

AVerMedia® AVerVision CP130

User Manual

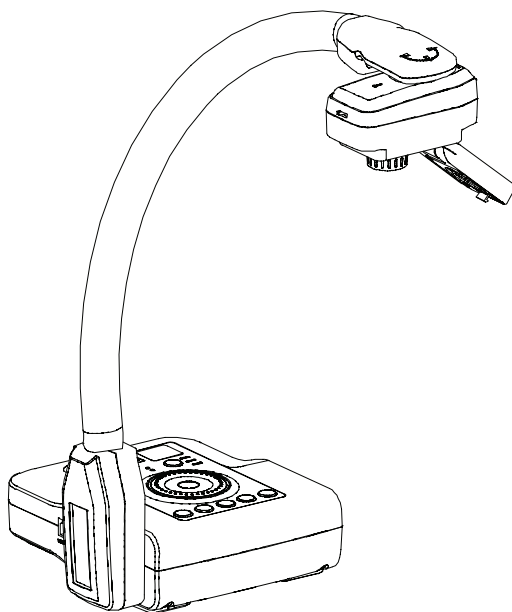

AVerMedia

AVerMedia®
Digital Document Camera



P/N 300AP0A7-CPD
Made in Taiwan

FCC NOTICE (Class A)



This device complies with Part 15 of the FCC Rules. Operation is subject to the following two conditions: (1) this device may not cause harmful interference, and (2) this device must accept any interference received, including interference that may cause undesired operation.

Federal Communications Commission Statement

NOTE- This equipment has been tested and found to comply with the limits for a Class A digital device, pursuant to Part 15 of the FCC Rules. These limits are designed to provide reasonable protection against harmful interference in a residential installation. This equipment generates uses and can radiate radio frequency energy and, if not installed and used in accordance with the instructions, may cause harmful interference to radio communications. However, there is no guarantee that interference will not occur in a particular installation. If this equipment does cause harmful interference to radio or television reception, which can be determined by tuning the equipment off and on, the user is encouraged to try to correct the interference by one or more of the following measures:

- Reorient or relocate the receiving antenna.
- Increase the separation between the equipment and receiver.
- Connect the equipment into an outlet on a circuit different from that to which the receiver is connected.
- Consult the dealer or an experienced radio/television technician for help.

Class A ITE:

Class A ITE is a category of all other ITE which satisfies the class A ITE limits but not the class B ITE limits. Such equipment should not be restricted in its sale but the following warning shall be included in the instructions for use:

Warning - This is a class A product. In a domestic environment this product may cause radio interference in which case the user may be required to take adequate measures.

CE Class A (EMC)



This product is herewith confirmed to comply with the requirements set out in the Council Directives on the Approximation of the laws of the Member States relating to Electromagnetic Compatibility Directive 2004/108/EEC.

Warning - This is a Class A product. In a domestic environment this product may cause radio interference in which case the user may be required to take adequate measures to correct this interference.

DISCLAIMER

No warranty or representation, either expressed or implied, is made with respect to the contents of this documentation, its quality, performance, merchantability, or fitness for a particular purpose. Information presented in this documentation has been carefully checked for reliability; however, no responsibility is assumed for inaccuracies. The information contained in this documentation is subject to change without notice.

In no event will AVerMedia be liable for direct, indirect, special, incidental, or consequential damages arising out of the use or inability to use this product or documentation, even if advised of the possibility of such damages.

TRADEMARKS

AVerVision is registered trademarks of AVerMedia Information, Inc. IBM PC is a registered trademark of International Business Machines Corporation. Macintosh is a registered trademark of Apple Computer, Inc. Microsoft is a registered trademark and Windows is a trademark of Microsoft Corporation. All other products or corporate names mentioned in this documentation are for identification and explanation purposes only, and may be trademarks or registered trademarks of their respective owners.

COPYRIGHT

© 2008 by AVerMedia INFORMATION, Inc. All rights reserved. No part of this publication may be reproduced, transmitted, transcribed, stored in a retrieval system, or translated into any language in any form by any means without the written permission of AVerMedia Information, Inc.



THE MARK OF CROSSED-OUT WHEELED BIN INDICATES THAT THIS PRODUCT MUST NOT BE DISPOSED OF WITH YOUR OTHER HOUSEHOLD WASTE. INSTEAD, YOU NEED TO DISPOSE OF THE WASTE EQUIPMENT BY HANDING IT OVER TO A DESIGNATED COLLECTION POINT FOR THE RECYCLING OF WASTE ELECTRICAL AND ELECTRONIC EQUIPMENT. FOR MORE INFORMATION ABOUT WHERE TO DROP OFF YOUR WASTE EQUIPMENT FOR RECYCLING, PLEASE CONTACT YOUR HOUSEHOLD WASTE DISPOSAL SERVICE OR THE SHOP WHERE YOU PURCHASED THE PRODUCT.

Table of Contents

Introduction.....	1
Package Contents	1
Optional Accessories.....	2
AVerVision CP130 Parts.....	3
Technical Specifications.....	4
Making the Connections.....	5
Connecting the Power Adapter	6
Connecting a TV	6
Connecting a VGA, Mac Display Monitor or LCD/DLP Projector	7
Connecting an IBM Compatible PC or Macintosh Computer	7
Installing the Optional Light Box	8
Connecting to a Microscope	9
Setting Up AVerVision CP130.....	9
Camera Head	9
LED Light.....	9
Flexible Gooseneck and Arm.....	10
Anti-glare Sheet.....	10
Touch Button Control Panel.....	11
OSD Navigation Tree.....	13
Menu Functions.....	14
Transferring the captured image to PC.....	17
Troubleshooting	17
Limited Warranty	18

Introduction

Thank you for purchasing the AVerMedia® AVerVision CP130. This document camera displays documents, negatives, transparencies and 3D objects onto a TV, LCD or DLP projector making presentations a snap.

AVerVision CP130 is an ideal presentation tool for business, academic, medical and the scientific community.

AVerMedia

Package Contents

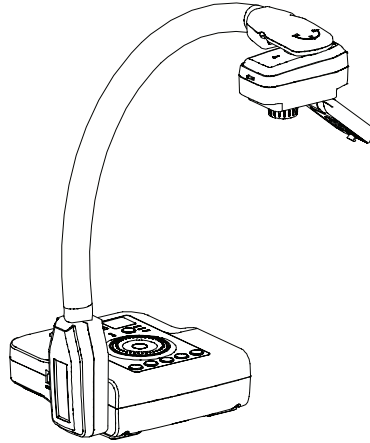

AVerMedia® AVerVision CP130



User Manual

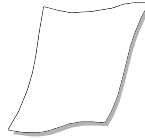

Anti-glare Sheet

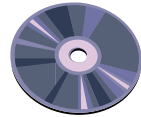

Driver CD

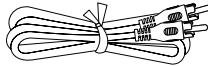

RCA Cable

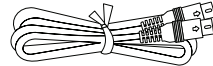

S-Video Cable

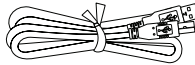

USB Cable

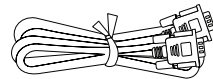

Computer Extension cable (VGA Cable)

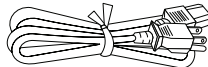

Power Cord

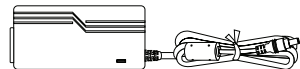

Power Adapter

* The power cord will vary depending on the standard power outlet of the country where it is sold.

Optional Accessories

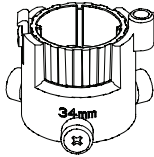

34mm Microscopic Adapter

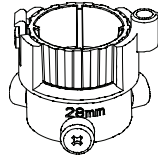

28mm Microscopic Adapter

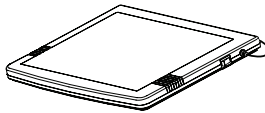

Light Box



Bag

AVerVision CP130 Parts

The illustrations below identify the parts of AVerVision CP130.

- (1) Camera head
- (2) LED light module
- (3) Camera lens
- (4) LED switch
- (5) Control panel
- (6) Right panel
- (7) Gooseneck
- (8) Rear panel
- (9) Left panel
- (10) Light box power port
- (11) DC 12V port
- (12) Antitheft slot
- (13) Camera head holder
- (14) S-Video output port
- (15) Composite video output port
- (16) RGB input port
- (17) RGB output port
- (18) TV-RGB switch
- (19) USB port

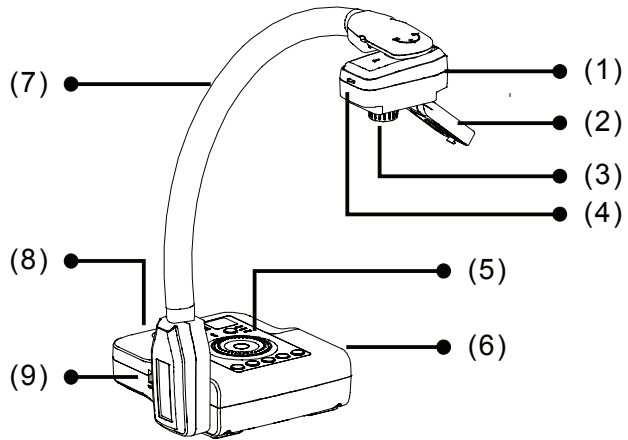

Right Panel

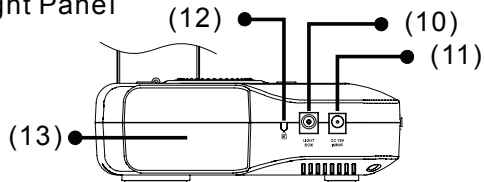

Rear Panel

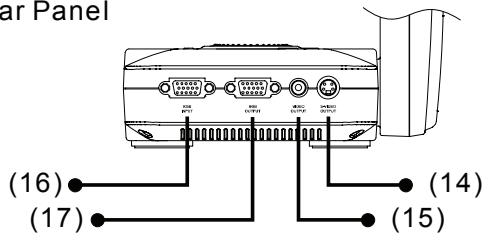

Left Panel

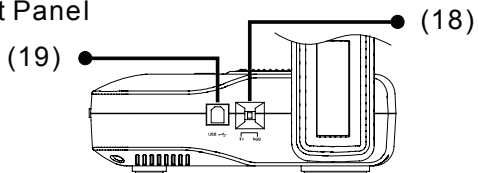

Technical Specifications

Image

Sensor	1/2" CMOS color image sensor
Total Pixels	850K
Frame Rate	12 fps (max.)
White Balance	Auto / Manual
Exposure	Auto / Manual / Flicker / Night View
Image mode	Text / Graphics
Effect	Color / B/W / Negative
Analog RGB output	XGA 60 Hz; SVGA 60 Hz; VGA 60 Hz
Image Capture	Up to 40 Frames

Optics

Lens	F3.0; fl=9.6mm
Focusing	Manual
Shooting Area	300mm x 225mm (max.)
Zooming	Digital Zoom: 8X

Power

Power Source	100-240V ~ 4.0-4.2A, 50-60Hz
Consumption	18 Watts (lamp off); 20 Watts (lamp on)

Lighting

Lamp Type	LED lamp without laser pointer
-----------	--------------------------------

Input/Output

VGA Input	15-Pins D-sub (VGA)
VGA Output	15-Pins D-sub (VGA)
S-Video	Mini-DIN Jack
Composite Video	RCA Jack
USB	USB2.0
DC 12V Input	Power Jack
Light Box	Power Jack (DC 6V Output)

Dimension

Operating	160mm x 170mm x 450mm
Folded	287.4mm x 232.5mm x 61mm
Weight	2.4 kg (about 5.3 lb)

Making the Connections

The ports on the rear, left and right panel of CP130 enable you to connect the unit to a computer, graphics display monitor or LCD/DLP projector, TV or other device. Illustrated below are the ports that are located at the rear, left and right panel of CP130 with their corresponding labels.

Right Panel

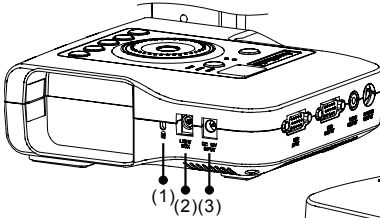

Rear & Left Panel

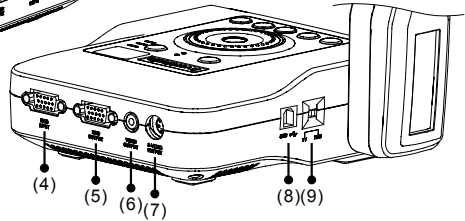

Port	Description
(1) Antitheft Slot	Attach a Kensington compatible security lock or antitheft device.
(2) Light Box	Plug the optional light box into this port.
(3) DC 12V	Connect the power adapter into this port.
(4) RGB INPUT	Input the signal from a computer or other sources and pass it through to the RGB Output port only. Connect this port to the VGA output port of the computer.
(5) RGB OUTPUT	Output the signal from the camera, RGB input port, or the captured images from the memory on a VGA/Mac monitor or LCD/DLP projector.
(6) VIDEO OUTPUT (RCA/Composite)	Output the signal from the camera or the captured images from the memory on TV or Video equipment.
(7) S-VIDEO OUTPUT	Output the signal from the camera or the captured images from the memory on TV or Video equipment.
(8) USB	Use CP130 as a USB Camera or transfer the captured images from CP130 memory to PC.
(9) TV-RGB switch	Switch to output display video either from Video, S-VIDEO, or RGB output port.

Connecting the Power Adapter

Connect the power adapter to a standard 100V~240V AC power source.

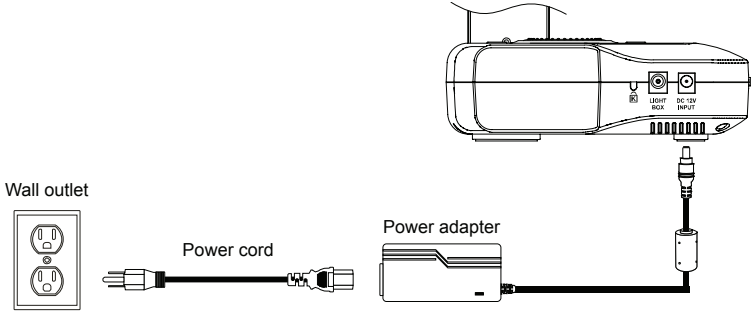

Connecting a TV

Locate the video, S-VIDEO or SCART RGB input port of the TV or Video equipment (i.e., VCR) to record your presentation on a videotape and connect it to S-VIDEO or VIDEO OUTPUT port of CP130. If you are not sure, please refer to the user manual of the TV or Video equipment.



Make sure the TV/RGB switch is set to TV.

For better video quality, we strongly suggest using S-VIDEO connection.

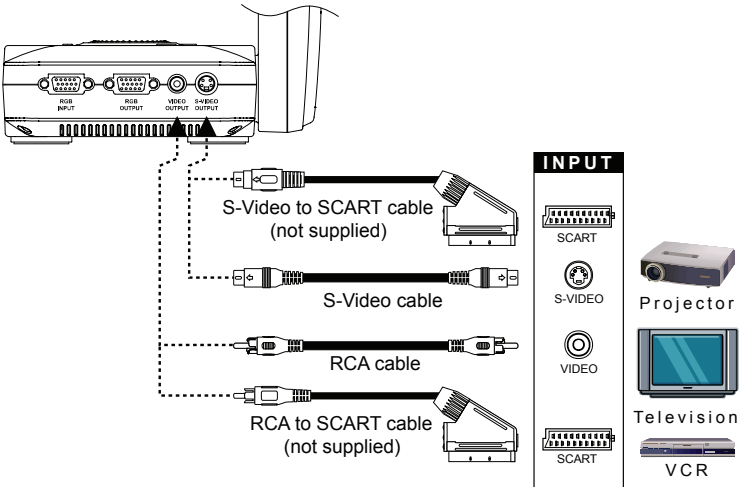

Connecting a VGA, Mac Display Monitor or LCD/DLP Projector

Locate the RGB (VGA) input port of the display device and connect it to RGB OUTPUT port of CP130. If you are not sure, please refer to the user manual of the device.



Make sure the TV/RGB switch is set to RGB.

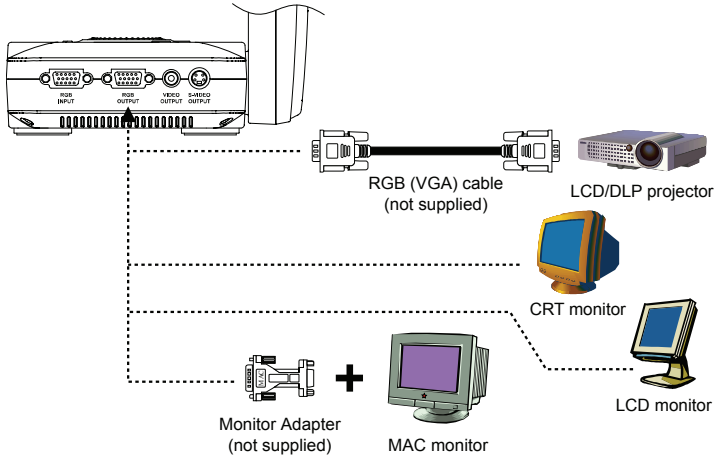

Connecting an IBM Compatible PC or Macintosh Computer

Locate the VGA output port of the computer or laptop to display your PC presentation on screen and connect it to RGB INPUT port of CP130. The video signal from the RGB INPUT port is streamed to RGB OUTPUT port and displayed on the screen.

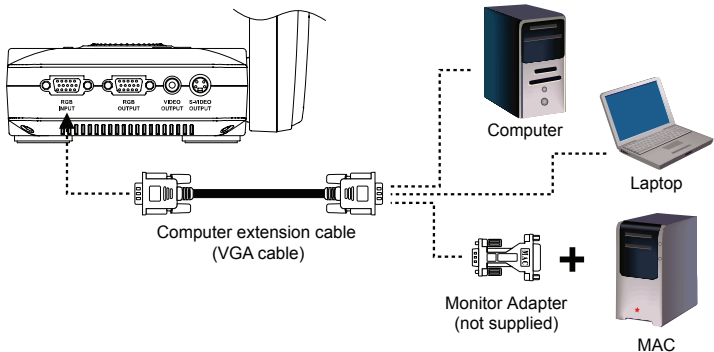

Connecting a Computer via USB Connection

Locate the USB port of the computer or laptop and connect it to USB port of CP130. This enables you to use CP130 as a USB Camera and to transfer the captured images from the memory and to computer. Also see "Transfer Image from AVerVision CP130 to PC".

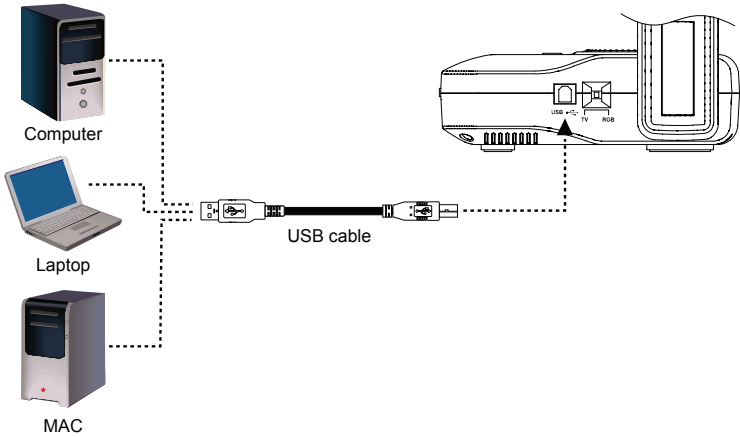

Installing the Optional Light Box

Connecting an optional light box enables you to view x-rays, transparencies and negative slides.

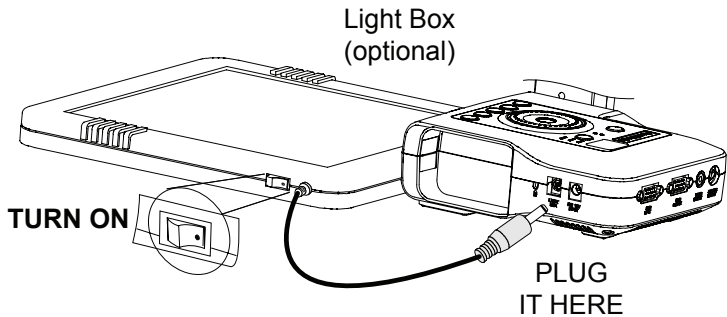

Connecting to a Microscope

Connecting the CP130 to a microscope enables you to examine microscopic objects on a big screen without straining your eyes.

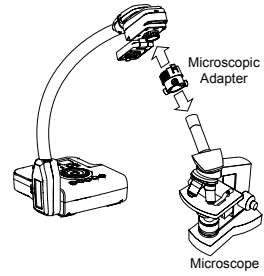

Setting Up AVerVision CP130

This section provides useful tips on how to adjust the CP130 to meet your needs.

Camera Head

The camera head can be turned 90° to the left and right. The latch must be pressed to open and unfold the LED light. You can also manually adjust the focus from the focus ring to improve the quality of the pictures.



Make sure to unfold the LED light fully.

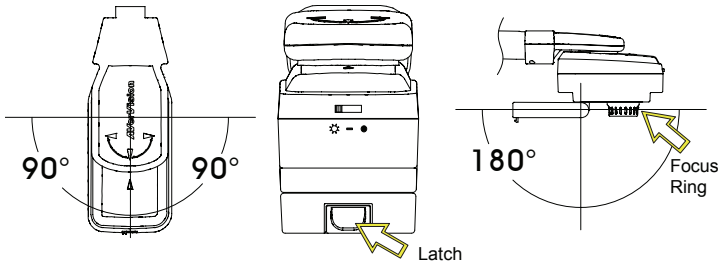

LED Light

The LED light provides white light and is best used when presenting in low light conditions.



Turn On

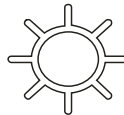

Turn Off



Flexible Gooseneck and Arm

The flexible gooseneck and arm design allows you to position the camera head from any angle.

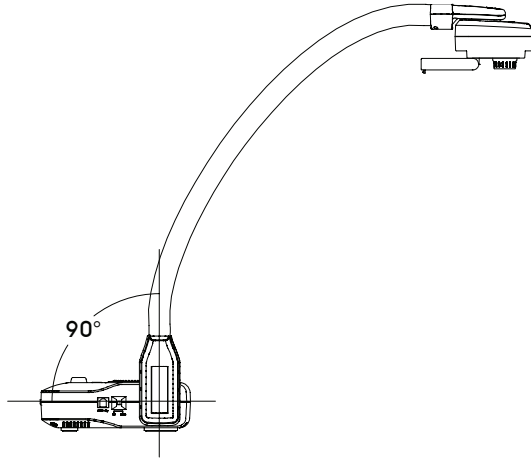

Anti-glare Sheet

The anti-glare sheet is a special coated film that helps eliminate any glare that maybe encountered while displaying very shiny objects or glossy surfaces such as magazines and pictures. To use, simply place the anti-glare sheet on top of the shiny document to reduce reflected light.

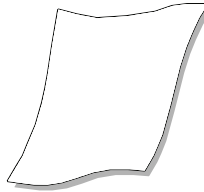

Touch Button Control Panel

The touch button control panel located on the top side of the CP130 provides quick access to commonly used functions.

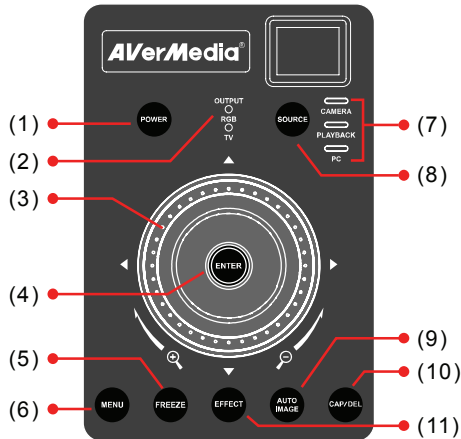

Function	Description
(1) POWER	Turn the unit on/off.
(2) Output LED Indicator	Indicate the setting of the TV to RGB switch to which the video signal is being sent out.
(3) Shuttle Wheel	<ul style="list-style-type: none"> - Turn the shuttle wheel clockwise to zoom in and counter-clockwise to zoom out the image in Camera and Playback mode only. The image can digitally zoom up to 800%. Press ENTER to return to normal view (100%). - Press the shuttle wheel ▲, ▼, ◀, & ▶ to pan the image while in zoom in mode, to make a selection on 16-thumbnail images or move to the next or previous single full screen preview in Playback mode, or to make a selection and adjustment on the OSD main-menu and sub-menu (See Menu Functions for more details).
(4) ENTER	Make a selection in Playback mode and OSD menu.
(5) FREEZE	Toggle to pause or resume the camera.
(6) MENU	Pull up and exit the OSD main-menu and sub-menu.
(7) Source LED Indicator	Indicate the source of the video signal or image.

Function	Description
(8) SOURCE	<p>Switch between Camera, Playback and PC mode.</p> <ul style="list-style-type: none"> - Camera mode displays the video signal from the built-in camera.
<div style="background-color: yellow; padding: 2px;">SLIDE SHOW</div> <div style="background-color: green; padding: 2px;">START</div> <div style="background-color: blue; padding: 2px;">INTERVAL</div>	<ul style="list-style-type: none"> - Playback mode displays the captured image from the built-in memory in 16-thumbnail images. Use ▲, ▼, ◀, & ▶ buttons to make a selection and ENTER to display the selected image in full screen. To start slide show press MENU and select START and press ENTER to begin and end. Select INTERVAL to set the display time interval between frames in second. - PC mode displays the video signal from the RGB INPUT port of AVerVision CP130.
(9) AUTO IMAGE	Automatically adjust and set the white balance and exposure setting.
(10) CAP/DEL	<ul style="list-style-type: none"> - Capture a still image in Camera mode. The captured image is saved in the built-in memory at 1024 x 768 resolution and can store up to 40 images. - Remove the selected picture from the built-in memory permanently in Playback mode.
(11) EFFECT	Convert and display the image in BW, Negative or Color in Camera and Playback mode only.



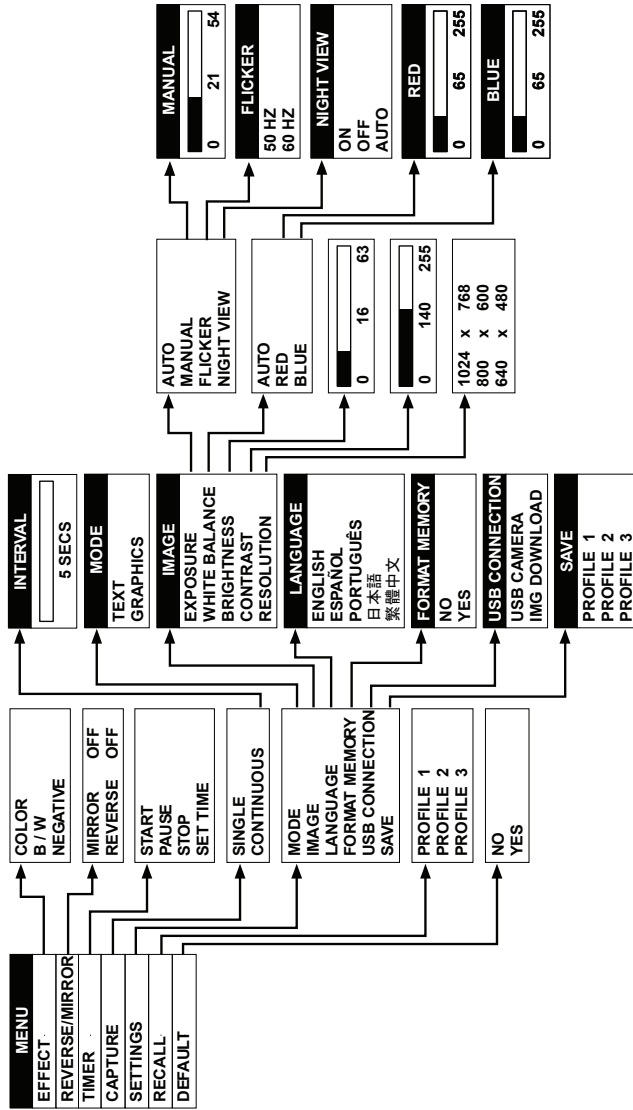





OSD Navigation Tree

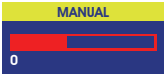

Menu Functions

The MENU functions of CP130 enhance fine-tuning your screen display, set the timer, select OSD language and more. Press the **MENU** button to call up and exit from the main menu or sub-menu display. Then use **▲** or **▼** buttons to select the items in the menu list. Use **▶/ENTER** button to enter sub-menu and **◀/ENTER** to return to main menu. To adjust the setting, press **◀** or **▶** buttons. To make a selection, press **ENTER**.

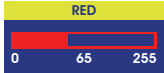
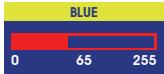
OSD Menu	Description
	EFFECT Press ▶ and use ▲ or ▼ buttons to select and display the image in Camera mode into positive (true color), monochrome (black and white) or negative. Then press ▶/ENTER to make a selection.
	REVERSE / MIRROR Press ▶ and use ▲ or ▼ buttons to select and turn on MIRROR to flip the image and REVERSE to rotate the image by 180° in Camera mode. Then press ▶/ENTER to make a selection.
	TIMER Press ▶ and use ▲ or ▼ buttons to select SET TIME to set the time value, START to begin the countdown timer, PAUSE/RESUME to temporarily halt or continue, and STOP to end.
	CAPTURE Press ▶ and use ▲ or ▼ buttons to select SINGLE or CONTINUOUS capture mode. Setting SINGLE saves one still image only and CONTINUOUS saves successive still images until the built-in memory is full or when the CAP/DEL button is being press again to stop.
	In Continuous mode, use ◀ or ▶ buttons to increase or decrease the capture time interval between frames and then press ENTER to save the setting and exit. The time interval can be set from 5 to 600 sec.
	SETTINGS Press ▶ , then use ▲ or ▼ buttons to select the items in SETTINGS list and press ▶/ENTER .
	SETTINGS > MODE Use ▲ or ▼ buttons to select between Text and Graphics enhancement mode and then ENTER to make a selection.

OSD Menu	Description
	<ul style="list-style-type: none"> • Text - corrects the intensity of the adjacent pixel making it more uniform producing sharper and clearer images. • Graphics - adjusts the gradient of the adjacent pixel making it appears to have a smooth image.
	<p>SETTINGS > IMAGE > EXPOSURE</p> <p>Press ▶ and use ▲ or ▼ buttons to select between Auto, Manual, Flicker and Night View. Then press ▶/ENTER to make a selection.</p> <p>Select AUTO to automatically adjust the camera exposure to determine how much light is required.</p>
	<p>SETTINGS > IMAGE > EXPOSURE > MANUAL</p> <p>Press ▶/ENTER and use ◀ or ▶ buttons to manually adjust the exposure level then press ENTER to save the setting and exit.</p>
	<p>SETTINGS > IMAGE > EXPOSURE > FLICKER</p> <p>Use ▲ or ▼ buttons to select between 50Hz or 60Hz. Some display devices cannot handle high refresh rates. The image will flicker a couple of times as the output is switched to another refresh rate.</p>
	<p>SETTINGS > IMAGE > EXPOSURE > NIGHT VIEW</p> <p>Use ▲ or ▼ buttons to turn Night View ON, OFF or AUTO.</p> <p>If you are presenting in a low-light condition, Night View enables the image of the object to appear as though under normal lighting conditions. CP130 can automatically adjust the exposure to compensate for the adverse condition, but the captured image will appear to be in slow motion.</p>
	<p>SETTINGS > IMAGE > EXPOSURE > WHITE BALANCE</p> <p>Press ▶ and use ▲ or ▼ buttons to select between Auto or manually adjust the Red and Blue color to suit the lighting condition or color temperature. Then press ▶/ENTER to make a selection.</p>
	<p>SETTINGS > IMAGE > EXPOSURE > WHITE BALANCE > RED</p> <p>Use ◀ or ▶ buttons to manually adjust the red color level then press ENTER to save the setting and exit.</p>
	<p>SETTINGS > IMAGE > EXPOSURE > WHITE BALANCE > BLUE</p> <p>Use ◀ or ▶ buttons to manually adjust the blue color level then press ENTER to save the setting and exit.</p>
	<p>SETTINGS > IMAGE > BRIGHTNESS</p> <p>Use ◀ or ▶ buttons to increase or decrease the brightness level and improve the visibility of the image. The brightness level can be set up to 63.</p>

OSD Menu	Description
	<p>SETTINGS > IMAGE > CONTRAST</p> <p>Use ◀ or ▶ buttons to emphasize or reduce the difference between light and dark conditions. The contrast level can be adjustable up to 255.</p>
	<p>SETTINGS > IMAGE > RESOLUTION</p> <p>Press ▶/ENTER and use ▲ or ▼ buttons to choose from different display resolutions then press ▶/ENTER to make the selection.</p> <p>This selection will not be available in TV output (Composite/S-Video)</p>
	<p>SETTINGS > LANGUAGE</p> <p>Use ▲ or ▼ buttons to select from different languages then press ▶ to make the selection.</p>
	<p>SETTINGS > FORMAT MEMORY</p> <p>Use ▲ or ▼ buttons to select NO to exit or YES to format and delete all the images saved in the built-in memory then press ▶/ENTER.</p> <p>Please wait till the message "FORMAT" disappear to finish the process.</p>
	<p>SETTINGS > USB SELECT</p> <p>Use ▲ or ▼ buttons to select the USB function between USB Camera and Img Download.</p> <ul style="list-style-type: none"> • USB Camera - can be used as a computer webcam or with our bundled software as video recorder and capture still image. • Img Download - transfer the captured images from the built-in memory to computer hard disk.
	<p>SETTINGS > SAVE</p> <p>Use ▲ or ▼ buttons to select which profile slot to save your preferred setting. Only effect, mode, brightness and contrast settings can be saved.</p>
	<p>RECALL</p> <p>Press ▶ then use ▲ or ▼ buttons to select from the list to revert to the preferred saved profile setting and press ▶/ENTER to make the selection.</p>
	<p>DEFAULT</p> <p>Press ▶ and use ▲ or ▼ buttons to select YES to restore to original factory default setting or NO to exit then press ▶/ENTER to make the selection.</p>

Transferring the captured image to PC

This enables you to transfer the captured image from the built-in memory to PC.



The instruction below **MUST** be read and followed **BEFORE** connecting the USB cable.

1. **MUST** set the USB CONNECTION as IMG DOWNLOAD before connecting the USB cable.

To set the USB CONNECTION as IMG DOWNLOAD, press **MENU** > select **SETTING** and press (▶), select **USB CONNECTION** and press (▶), select **IMG DOWNLOAD** and press (▶/ENTER), and **MENU** to close the OSD menu.

2. When “IMG DOWNLOAD” appears at the lower right corner of the presentation screen, you may now connect the USB cable.
3. Upon connecting the USB cable, the system automatically detects the new removable disk. You may now transfer the captured image(s) from the CP130 built-in memory to PC hard disk.

Troubleshooting

This section provides many useful tips on how to solve common problems while using the CP130.

There is no picture on the presentation screen.

1. Check all the connectors again as shown in this manual.
2. Check the on/off switch of the display output device.
3. Verify the setting of the display output device.
4. If you are presenting from a notebook or computer through the display output device, please check and switch the document camera source to PC Mode.

I have set up the CP130 and checked all the connections as specified in the manual but I cannot get a picture on the preferred presentation screen.

1. The unit POWER button turns orange in standby mode. Press the POWER button again to turn on and the LED light will turn blue.
2. The default camera display resolution setting is on 1024x768. If your output device does not support this resolution; no image can be projected. Simply press hold the MENU and ▶ button to the increase or decrease the resolution setting.
3. If your display output device is TV or any analog device, please switch the TV-RGB dip switch to TV.

The picture on the presentation screen is distorted or the image is blurry.

1. Reset all changed settings, if any, to the original manufacturer default setting (Refer to the Menu Functions for more details and steps).

2. Use the Brightness and Contrast menu functions to reduce the distortion if applicable.
3. If you discover that the image is blurry or out of focus, adjust the focus ring on the camera head.

There is no computer signal on presentation screen.

1. Check all the cable connections among the display device, CP130 and your PC.
2. Connect your PC to the CP130 first before you power on your computer.
3. Make sure to switch your laptop to output display on external display device.

Limited Warranty

For a period of time beginning on the date of purchase of the applicable product and extending as set forth in the **“Warranty Period of AVerMedia Product Purchased”** section of the warranty card, AVerMedia Information, Inc. (“AVerMedia”) warrants that the applicable product (“Product”) substantially conforms to AVerMedia’s documentation for the product and that its manufacture and components are free of defects in material and workmanship under normal use. “You” as used in this agreement means you individually or the business entity on whose behalf you use or install the product, as applicable. This limited warranty extends only to You as the original purchaser. Except for the foregoing, the Product is provided “AS IS.” In no event does AVerMedia warrant that You will be able to operate the Product without problems or interruptions, or that the Product is suitable for your purposes. Your exclusive remedy and the entire liability of AVerMedia under this paragraph shall be, at AVerMedia’s option, the repair or replacement of the Product with the same or a comparable product. This warranty does not apply to (a) any Product on which the serial number has been defaced, modified, or removed, or (b) cartons, cases, batteries, cabinets, tapes, or accessories used with this product. This warranty does not apply to any Product that has suffered damage, deterioration or malfunction due to (a) accident, abuse, misuse, neglect, fire, water, lightning, or other acts of nature, commercial or industrial use, unauthorized product modification or failure to follow instructions included with the Product, (b) misapplication of service by someone other than the manufacturer’s representative, (c) any shipment damages (such claims must be made with the carrier), or (d) any other causes that do not relate to a Product defect. The Warranty Period of any repaired or replaced Product shall be the longer of (a) the original Warranty Period or (b) thirty (30) days from the date of delivery of the repaired or replaced product.

Limitations of Warranty

AVerMedia makes no warranties to any third party. You are responsible for all claims, damages, settlements, expenses, and attorneys’ fees with respect to claims made against You as a result of Your use or misuse of the Product. This warranty applies only if the Product is installed, operated, maintained, and used in accordance with AVerMedia specifications. Specifically, the warranties do not extend to any failure caused by (i) accident, unusual physical, electrical, or electromagnetic stress, neglect or misuse, (ii) fluctuations in electrical power beyond AVerMedia specifications, (iii) use of the Product with any accessories or options not furnished by AVerMedia or its authorized agents, or (iv) installation, alteration, or repair of the Product by anyone other than AVerMedia or its authorized agents.

Disclaimer of Warranty

EXCEPT AS EXPRESSLY PROVIDED OTHERWISE HEREIN AND TO THE MAXIMUM EXTENT PERMITTED BY APPLICABLE LAW, AVERMEDIA DISCLAIMS ALL OTHER WARRANTIES WITH RESPECT TO THE PRODUCT, WHETHER EXPRESS, IMPLIED, STATUTORY OR OTHERWISE, INCLUDING WITHOUT LIMITATION, SATISFACTORY QUALITY, COURSE OF DEALING, TRADE USAGE OR PRACTICE OR THE IMPLIED WARRANTIES OF MERCHANTABILITY, FITNESS FOR A PARTICULAR PURPOSE OR NONINFRINGEMENT OF THIRD PARTY RIGHTS.

Limitation of Liability

IN NO EVENT SHALL AVERMEDIA BE LIABLE FOR INDIRECT, INCIDENTAL, SPECIAL, EXEMPLARY, PUNITIVE, OR CONSEQUENTIAL DAMAGES OF ANY NATURE INCLUDING, BUT NOT LIMITED TO, LOSS OF PROFITS, DATA, REVENUE, PRODUCTION, OR USE, BUSINESS INTERRUPTION, OR PROCUREMENT OF SUBSTITUTE GOODS OR SERVICES ARISING OUT OF OR IN CONNECTION WITH THIS LIMITED WARRANTY, OR THE USE OR PERFORMANCE OF ANY PRODUCT, WHETHER BASED ON CONTRACT OR TORT, INCLUDING NEGLIGENCE, OR ANY OTHER LEGAL THEORY, EVEN IF AVERMEDIA HAS ADVISED OF THE POSSIBILITY OF SUCH DAMAGES. AVERMEDIA'S TOTAL, AGGREGATE LIABILITY FOR DAMAGES OF ANY NATURE, REGARDLESS OF FORM OF ACTION, SHALL IN NO EVENT EXCEED THE AMOUNT PAID BY YOU TO AVERMEDIA FOR THE SPECIFIC PRODUCT UPON WHICH LIABILITY IS BASED.

Governing Law and Your Rights

This warranty gives You specific legal rights; You may also have other rights granted under state law. These rights vary from state to state.



For warranty period, please refer to the warranty card.
