

FCC NOTICE

FCC ID: J4EK0A3

This device has been tested and found to comply with the limits for a Class B digital device, pursuant to Part 15 of the FCC Rules. These limits are designed to provide reasonable protection against harmful interference in a commercial, industrial or business environment. This equipment can generate, use and radiate radio frequency energy and, if not installed and used in accordance with the instruction, may cause harmful interference to radio communications. However, there is no guarantee that interference will not occur in a particular installation. If this equipment does cause harmful interference to radio or television reception, which can be determined by turning the equipment off and on, the user is encouraged to try to correct the interference by one or more of the following measures :

- Reorient or relocate the receiving antenna.
- Increase the separation between the equipment and receiver.
- Connect the equipment into an outlet on a circuit different from that to which the receiver is connected.
- Consult the dealer or an experienced radio/TV technician for help.

This device complies with Part 15 of the FCC Rules. Operation is subject to the following two conditions: (1) this device may not cause harmful interference, and (2) this device must accept any interference received, including interference that may cause undesired operation.

CAUTION ON MODIFICATIONS

To comply with the limits for the Class B digital device, pursuant to Part 15 of the FCC Rules, this device must be installed in computer equipment certified to comply with the Class B limits. All cables used to connect the computer and peripherals must be shielded and grounded. Operation with non-certified computers or non-shielded cables may result in interference to radio or television reception.

Any changes or modifications not expressly approved by the grantee of this device could void the user's authority to operate the equipment.

CE NOTICE

This is a Class B product.

DISCLAIMER

No warranty or representation, either expressed or implied, is made with respect to the contents of this documentation, its quality, performance, merchantability, or fitness for a particular purpose. Information presented in this documentation has been carefully checked for reliability; however, no responsibility is assumed for inaccuracies. The information contained in this documentation is subject to change without notice.

In no event will AVerMedia be liable for direct, indirect, special, incidental, or consequential damages arising out of the use or inability to use this product or documentation, even if advised of the possibility of such damages.

TRADEMARKS

AVerMedia and AVerKey are registered trademarks of AVerMedia TECHNOLOGIES, Inc. IBM PC is a registered trademark of International Business Machines Corporation. Macintosh is a registered trademark of Apple Computer, Inc. Microsoft is a registered trademark and Windows is a trademark of Microsoft Corporation. All other products or corporate names mentioned in this documentation are for identification and explanation purposes only, and may be trademarks or registered trademarks of their respective owners.

COPYRIGHT

© 1998 by AVerMedia TECHNOLOGIES, Inc. All rights reserved. No part of this publication may be reproduced, transmitted, transcribed, stored in a retrieval system, or translated into any language in any form by any means without the written permission of AVerMedia TECHNOLOGIES, Inc.

Table of Contents

Chapter 1 Introduction

| | |
|-----------------------------------|---|
| Product Highlights | 1 |
| What's in the Package | 2 |
| Features and Specifications | 3 |
| System Requirements | 5 |

Chapter 2 Hardware Installation and Setup

| | |
|--|----|
| Connecting AVerKey300 to the Computer and Monitor | 6 |
| Connecting an IBM PC and VGA Monitor | 7 |
| Connecting a Macintosh (or NEC) Computer and Display Monitor | 8 |
| Connecting a SCART RGB Monitor | 9 |
| Connecting the TV | 10 |

Chapter 3 Using the AVerKey300

| | |
|--------------------------------------|----|
| Using the Remote Control | 11 |
| Touch Button Panel | 15 |
| The LED Panel | 16 |
| Special Highlighting Functions | 17 |
| AVerMedia Spot | 17 |
| AVerMedia Pointer | 18 |
| AVerMedia Spylight | 20 |
| Different Types of Zoom | 22 |
| Normal Zoom | 22 |
| AVerMedia Area Zoom | 22 |
| AVerMedia Spot-Zoom | 23 |
| AVerMedia Pointer-Zoom | 24 |

Chapter 4 Troubleshooting

Appendix Supported Display Modes

CHAPTER 1

INTRODUCTION

Thank you for purchasing the **AVerKey300**. We are certain you will find this product a useful video presentation tool that is highly suitable for your business and multimedia applications.

To get you started, this chapter briefly describes what the **AVerKey300** has to offer. At the end of the chapter, you will find the system requirements needed in order to use this product.

Product Highlights

The **AVerKey300** is an external PC/MAC/NEC-to-TV scan converter. It can convert computer images into video format and display them on any TV monitor or large-screen LCD projector. True Plug & Play with no software drivers required, the **AVerKey300** is compatible with all computers, notebooks and operating systems.

The **AVerKey300** offers many exciting new features to enhance your presentations. Four very special features are the *Area Zoom*, *AVerMedia Spot-Zoom*, *AVerMedia Pointer-Zoom*, *AVerMedia Spotlight*. They are special highlighting functions which allow you to focus on specific areas of your screen and emphasize key points in your presentation. The **AVerKey300** provides up to 7 *Selectable Sharpness Controls* to choose from. *Full Screen Underscan/Overscan* and *Horizontal/Vertical Adjustment* prevents images from being "chopped out". The *Screen Freeze* function allows you to pause video output and make last-minute changes to your presentations. And with Super-VGA compatibility, your applications can be converted into resolutions up to 1600 x 1200 (PC and MAC) in 16.7 million colors. All of these features (and more) can be easily accessed with the *Infrared Remote Control*.

Even without the remote, you will still be able to operate the **AVerKey300**. It has a built-in *Touch Button Control Panel* which gives you access to many key functions.

What's in the Package

Your **AVerKey300** package includes the following :



AVerKey300 Scan Converter and Remote Control (batteries included)

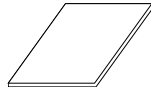

This User's Manual

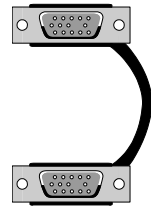

Computer Extension Cable (VGA Cable)



AC Power Adapter Unit



S-Video Cable



AV Cable

Optional Accessories :

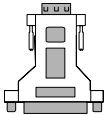

Monitor Adapter (for MAC/NEC)

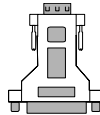

Computer Adapter (for MAC/NEC)

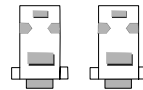

12" and 14" Dummy Terminators (for MAC)

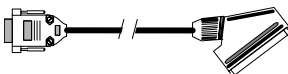

SCART Cable (optional on PAL version)

Features and Specifications

The **AVerKey300** provides the following features and specifications :

Features

- Plug and Play, no software drivers required.
- Compatible with all PCs, MACs, NEC 98 family PCs, and Laptops.
- Wireless remote control access to all functions.
- Touch-button control panel.
- Supports resolutions up to 1600 x 1200 (PC and MAC) with 16.7 million colors.
- Up to 7 levels of flicker-filter selection for sharpness control.
- Simultaneous display on computer and TV monitors (Supports all VGA monitors and MultiScan MAC monitors).
- 3 types of Highlighting functions :

- * *AVerMedia Spot*

This function highlights a certain area on the image by darkening external areas and by creating a colored border within your area of interest. Create a highlight as large as 1/4th of your screen or as small as 1/64th of your presentation screen.

- * *AVerMedia Pointer*

Similar to a Laser Pointer, the *AVerMedia Pointer* is a 4 x 4 pixel square that lets you direct your viewers attention to key areas on the screen.

- * *AVerMedia Spotlight*

This function highlights certain areas of your screen by darkening unwanted areas. You can darken areas horizontally or vertically.

- 4 types of Zoom :

- * *Traditional Zoom & Pan*

Users can zoom in (200%) the computer screen on TV display and pan around freely to any part of the screen.

- * *Exclusive AVerMedia Area Zoom*

Divides the computer screen into 9 parts and allows you to select the desired part through the “Area Zoom Control” on the remote.

- * *New AVerMedia Spot-Zoom*

After you highlight a certain area using *AVerMedia Spot*, you can zoom in and out of the highlighted area.

* *New AVerMedia Pointer-Zoom*

You can point to a key area in your presentation using *AVerMedia Pointer* and then enlarge that area.

- Zoom sharpness control.
- Screen freeze/unfreeze.
Screen freeze allows you to pause the video output and make last-minute changes to your presentations.
- Full-screen underscan/overscan.
Full-screen underscan/overscan ensures your screen images won't be "chopped off" on the borders of the screen.
(Note: Images will not be chopped off for resolutions up to 1600 x 1200.)
- Wide-range picture width and height adjustment.
- Horizontal/vertical picture positioning.
- Horizontal/vertical screen panning.
- TV brightness control.
- Composite/S/RGB video output.
- Save settings when powering off.

Specifications

| | |
|----------------|--|
| Input Signal: | VGA, RGB or MAC Horizontal frequency : 24KHz - 108KHz Vertical frequency : 56Hz - 120Hz |
| Output Signal: | Composite video, S-video, Computer monitor (PC, MAC or NEC) pass-thru output, SCART RGB video output |
| Power Supply: | 7.5VDC Power Adapter |
| Dimensions: | Base unit : 5.95" x 4.76" x 1.45" (15.11cm x 12.1cm x 3.7cm) Remote control : 7.24" x 2.2" x 0.65" (18.4cm x 5.6cm x 1.7cm) |
| Weight: | 0.77 lb. (349 grams) |
| Compliance: | FCC Class B |

System Requirements

To use the **AVerKey300**, you will need :

- IBM[®] PC or compatibles;
- Any Macintosh that support up to 1600 x 1200 display mode;
(MAC systems without the monitor output require a Power-R or Apple[®] adapter); or
- Any NEC computer from the NEC 98 Series

NOTE: **AVerKey300** should in theory support any computer and display systems with a vertical display frequency range of 56Hz to 120Hz and a horizontal display frequency of 24KHz to 108KHz. However, due to different custom hardware configurations and the wide variety of connectors used on various systems, we cannot guarantee that **AVerKey300** will function properly.

CHAPTER 2

HARDWARE INSTALLATION AND SETUP

This chapter will show you how to install the **AVerKey300** to an IBM compatible PC, Macintosh computer and NEC PC.

Connecting AVerKey300 to the Computer and Monitor

The ports on the back panel of the **AVerKey300** are for connecting the converter to the system unit and graphics display monitor. The figure and descriptions below specify what device should go into each port. (Text describing each port are printed at the bottom side of the converter.)

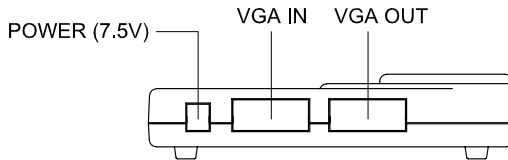

AVerMedia AVerKey300 Back Panel

POWER (7.5V) : Plug the *AC Power Adapter* to this port.

VGA IN : *For IBM PC or compatible :*

This port connects the **AVerKey300** to the IBM compatible PC's VGA port via the supplied *Computer Extension Cable*.

For Macintosh or NEC computer :

This port connects the **AVerKey300** to the Macintosh/NEC PC's display card via the

supplied *Computer Extension Cable*. (A *Computer Adapter* should be used to connect.)

VGA OUT : The computer monitor should be connected to this port. (A *Monitor Adapter* is needed to connect the Macintosh or NEC monitor.)

Connecting an IBM PC and VGA Monitor

To connect the **AVerKey300** with an IBM PC or compatible and a VGA monitor, follow the setup diagram and step-by-step procedure below.

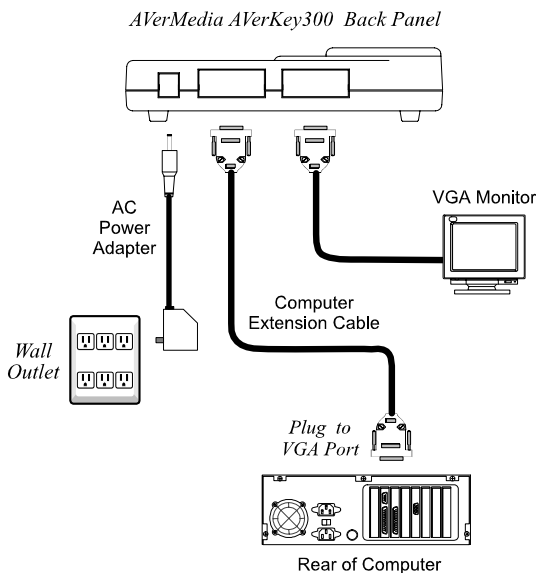

1. Connect the **AVerKey300** to the PC.
Plug one end of the supplied *Computer Extension Cable* to the **AVerKey300** “VGA IN” port and the other end to the PC’s VGA port.
2. Connect the VGA monitor to **AVerKey300**.
Plug the VGA monitor cable to the **AVerKey300** “VGA OUT” port.

3. Plug the supplied *AC Power Adapter* into the **AVerKey300** "POWER" port.

Connecting a Macintosh (or NEC) Computer and Display Monitor

To connect the **AVerKey300** with a Macintosh or NEC computer and a display monitor, follow the setup diagram and procedure below.

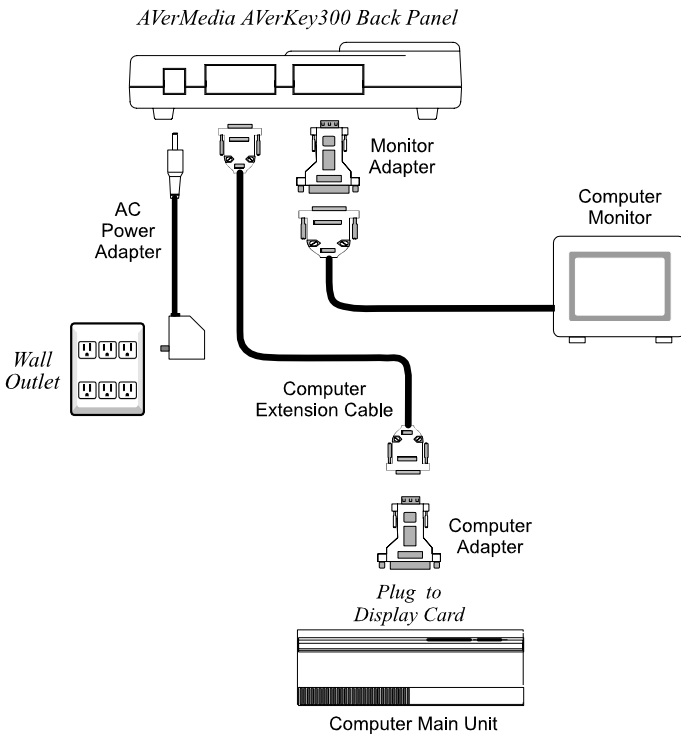

1. Use the supplied *Computer Extension Cable* and the *Computer Adapter* to connect **AVerKey300** to the Macintosh or NEC computer. (The *Computer Adapter* is provided as an option.)
 - Plug one end of the *Computer Extension Cable* to the **AVerKey300** "VGA IN" port.

- Attach the *Computer Adapter* to the other end of the *Computer Extension Cable*.
 - Connect the *Computer Extension Cable* with the attached *Computer Adapter* to the monitor port on the back panel of your Macintosh or NEC computer.
2. Connect your Macintosh or NEC monitor to the **AVerKey300**.
 - Disconnect the monitor from the computer.
 - Then, attach the *Monitor Adapter* to the monitor cable. (The *Monitor Adapter* is provided as an option.)
 - Connect the monitor cable with the attached *Monitor Adapter* to the **AVerKey300** “VGA OUT” port.
 3. If you do not intend to use a computer monitor with your Macintosh computer, you will need to connect a dummy terminator to the **AVerKey300** “VGA OUT” port. In general, a 14” terminator is used. A 12” terminator is only used with software that requires it.

Terminators are used with Macintosh and laptops when no external monitor is used. (12” and 14” terminators are provided as optional accessories with the **AVerKey300**.)

4. Plug the supplied *AC Power Adapter* into the **AVerKey300** “POWER” port.

Connecting a SCART RGB Monitor

If you are using a SCART RGB monitor, connect the monitor to the **SCART RGB** port at the side panel of **AVerKey300** using the *SCART RGB Cable*. (The *SCART RGB Cable* is provided as an optional accessory cable with the **AVerKey300**.)

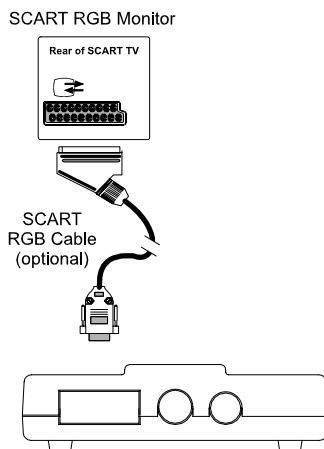

Connecting the TV

To display the computer screen on TV (or any video monitor), you will need to connect the TV to one of the ports at the **AVerKey300** side panel.

If the TV set uses the composite video standard, connect the TV to the **AVerKey300** "VIDEO" port using the supplied *AV Cable*.

If the TV set uses the S-video standard, connect the TV to the **AVerKey300** "S-VHS" port using the supplied *S-Video Cable*.

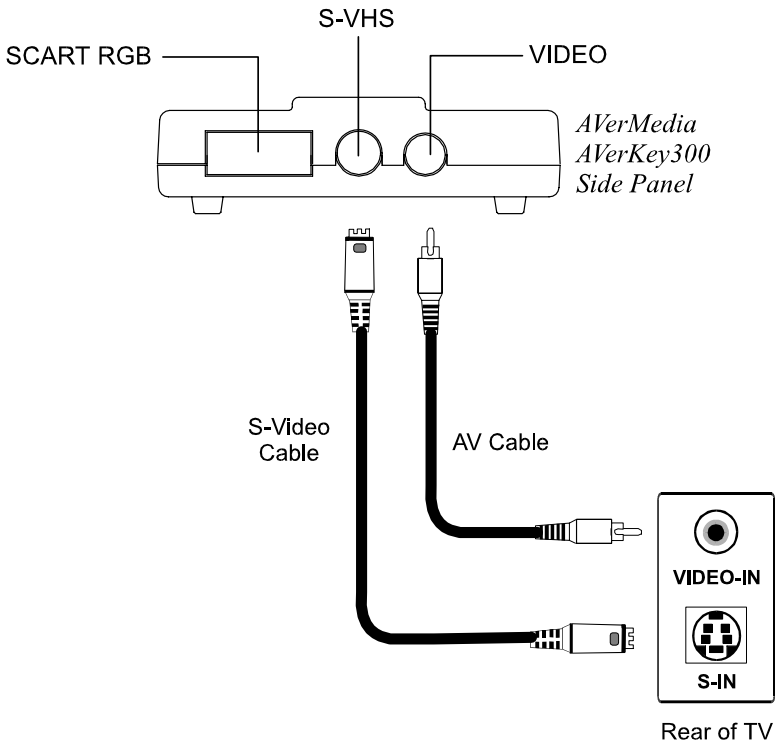

CHAPTER 3

USING THE AVerKey300

This chapter will show you how to use the *Remote Control Unit* and *Touch Button Control Panel* of the **AVerKey300**. At the end of this chapter, you will find details on using the special highlighting and zoom functions of the **AVerKey300**.

Using the Remote Control

To use the remote control, first insert the batteries (2 size “AA” batteries are provided) into the battery compartment at the back of the remote.

The *Infrared Sensor* is located at the front panel of the **AVerKey300** (see figure below). While using the remote, aim it at the infrared sensor.

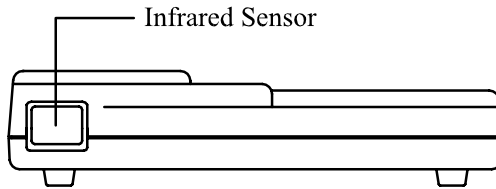

AVerMedia AVerKey300 Front Panel

The figure and descriptions on the following pages show you how to use the remote control.

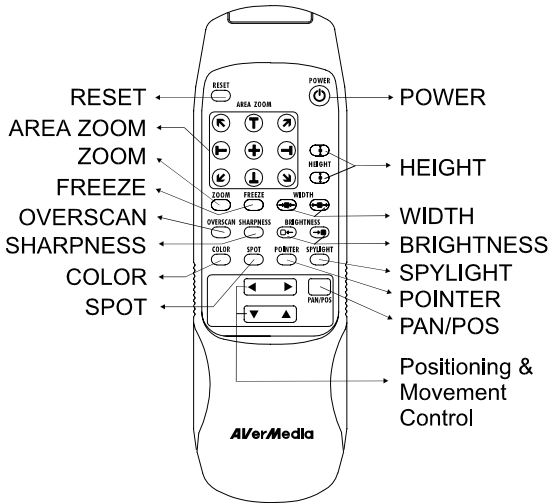

- POWER** : Switches the **AVerKey300** on/off.
- RESET** : Restores the **AVerKey300** to original factory settings.
- AREA ZOOM** : Provides quick selection of the screen area to magnify.

The *Area Zoom* function divides the computer image on the TV into 9 parts and allows you to select the desired part to zoom.

Refer to the section, *Different Types of Zoom*, for more details.
- ZOOM** : Press this button to zoom in or out of the computer image on TV.
- FREEZE** : Press this button to freeze or unfreeze the computer image on TV.



OVERSCAN : Toggles between *Underscan* and *Overscan*.

Overscan displays the computer image on TV to the fullest. The image will be chopped off at the borders when displayed this way.



When you switch to *Underscan*, the computer image will be completely displayed on TV.

Note: Images will not be chopped off for resolutions up to 1600 x 1200 in underscan mode.

SHARPNESS : This button is a cyclic switch which, when pressed successively, alternates with 7 levels of sharpness. Press this button repeatedly until you find the level of sharpness you want.

HEIGHT  : Press  to enlarge the height of the computer image on TV.

HEIGHT

 : Press  to reduce the height of the computer image on TV.

WIDTH : Press  to enlarge the width of the computer image on TV.



Press  to reduce the width of the computer image on TV.

BRIGHTNESS : Press  to decrease the brightness level.



Press  to increase the brightness level.

There are 4 brightness levels to choose from.

PAN/POS : Toggles between **PAN** and **POS** modes.

When you switch to **PAN** mode, pressing the **Positioning & Movement Control** buttons will allow you to move around the computer image on TV.

When you switch to **POS** mode, pressing the **Positioning & Movement Control** buttons will allow you to change the position of the computer image on the TV. You can move the image left, right, up, or down.

COLOR : This button is a cyclic switch which, when pressed successively, alternates with 8 types of colors. This button allows you to change the color of the *Pointer* and the frame surrounding the area highlighted by *AVerMedia Spot*.

Refer to the section, *Special Highlighting Functions*, for more details.

SPOT : Press this button to highlight a certain area in your presentation. The highlighted area will be surrounded by a colored frame and areas outside the frame will look dark. (Refer to the section, *Special Highlighting Functions*, for more details.)

POINTER : This button functions just like a laser pointer. (Refer to the section, *Special Highlighting Functions*, for more details.)

SPYLIGHT : Press this button to highlight certain areas of your presentation and darken the rest. (Refer to the section, *Special Highlighting Functions*, for more details.)

Positioning and Movement Control  : Use these buttons to :

- * Move around the computer image on TV.
- * Change the position of the image.
- * Move the *Pointer* to another area on-screen.
- * Highlight other areas on the screen.

Touch Button Panel

The figure and descriptions below show you how to use the *Touch Button Panel* on the hardware case.

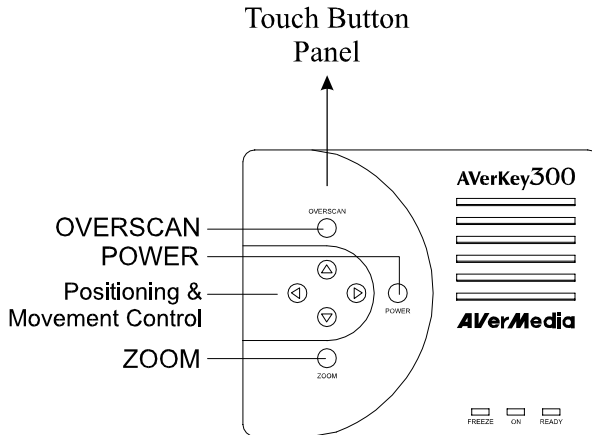

- POWER** : Switches the **AVerKey300** on/off.
- OVERSCAN** : Toggles between *Underscan* and *Overscan*. (Refer to the section, *Using the Remote Control*, for more details on this function.)
- ZOOM** : Press this button to zoom in or out of the computer image on TV.
- Positioning & Movement Control** : Use these buttons to :
 - * Move around the computer image on TV.
 - * Change the position of the image.
 - * Move the *Pointer* to another area on-screen.
 - * Highlight other areas on the screen.

The LED Panel

Aside from the touch button panel, you will also find an *LED Panel* on the **AVerKey300** hardware case.

The figure and descriptions below show what each LED indicator in this panel represents.

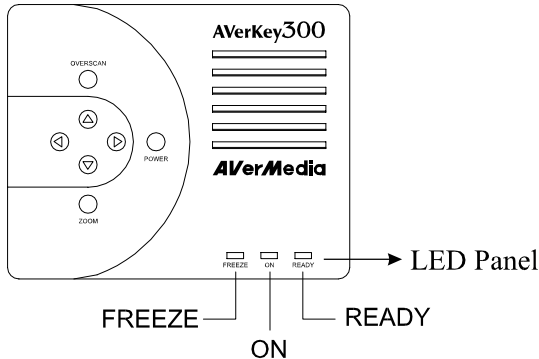

FREEZE : This LED shows whether FREEZE or UNFREEZE is in operation. (FREEZE is a red LED in the NTSC version and a green LED in the PAL version.)

If this LED is on, it means that the user has paused, that is, frozen the screen.

ON : This (green) LED is the power on/off indicator. If this LED is on, it indicates that the **AVerKey300** has been powered on.

READY : If this (red) LED is on, it indicates that the **AVerKey300** is ready for use.

Special Highlighting Functions

The **AVerKey300** provides 3 special functions for highlighting key points in any presentation : *AVerMedia Spot*, *AVerMedia Pointer* and *AVerMedia Spotlight*. You can use these functions by pressing the corresponding buttons on the remote control.

AVerMedia Spot

To highlight a certain area in your presentation, press the **SPOT** button on the remote.

A colored frame will appear around the highlighted area and the rest of the image will be darkened. The highlighted area will appear as if there is a "spotlight" directed on it. The figure below shows an illustration.

Highlighted Area

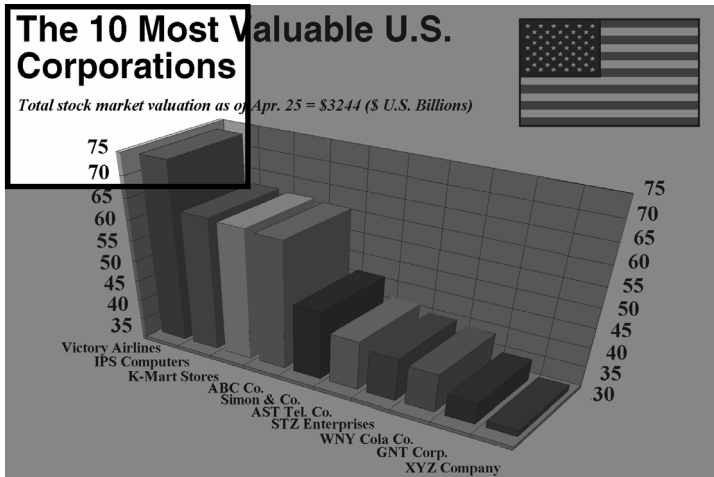

Changing the Size of the Highlight

You can adjust the size of the "spotlight", that is, the highlighted area. Use the **WIDTH** and **HEIGHT** buttons to create a highlight as large as 1/4th of your screen or as small as 1/64th of your presentation screen.

Changing the Color of the Frame

Use the **COLOR** button to select a color for the frame. There are 8 colors to choose from.

Changing the Highlight

To highlight another area in your presentation, use the **Positioning and Movement Control** buttons. Press the Up, Down, Left, and Right Arrows to direct the "spotlight" to another area.

AVerMedia Pointer

AVerMedia Pointer is very similar to the laser pointer. It is a 4 x 4 pixel square which lets you direct your viewer's attention to key areas in your presentation.

To point on a key area in your presentation, press the **POINTER** button on the remote. The figure below shows an illustration.



Extending the Point into a Line

If you have a very large audience, the *Point* on your presentation screen might not look obvious and clear enough. You can extend the *Point* into a *Line* :



Use the **WIDTH** buttons to extend the point into a line or change the line back into a point. At most, you can lengthen the line up to the full extent of your screen width.

Moving the Point (or Line)

Use the **Positioning and Movement Control** buttons to move the point (or line) up, down, left and right.

Changing the Color

Use the **COLOR** button to select a color for the point (or line). There are 8 colors to choose from.

AVerMedia Spotlight

Using *AVerMedia Spotlight* resembles the way you highlight parts of your presentation with an overhead projector. With Spotlight, you can highlight any portion you want and "cover" the rest by darkening areas which you do not want to show to your audience.

When you press the **SPYLIGHT** button for the first time, the upper part of your presentation screen will be highlighted :

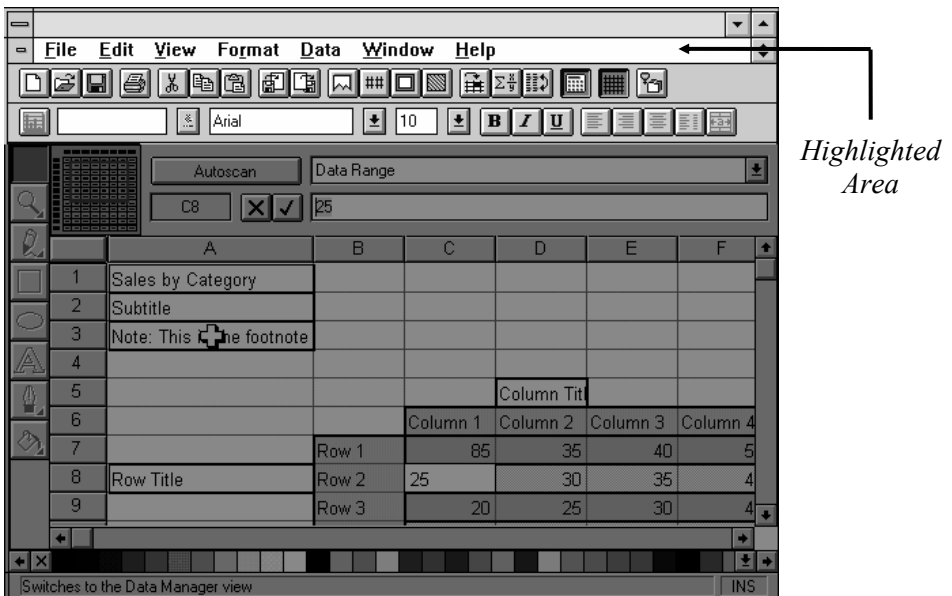

Highlighting Areas Horizontally and Vertically

You can use the **Positioning and Movement Control** buttons to slowly "expose" the rest of your presentation screen to your audience.

Press the Left, Right, Up, and Down Arrows to highlight more areas to the left, right, top, and bottom. Press the same buttons to "cover up" more portions of the screen and reduce the highlighted area.

Example 1 :

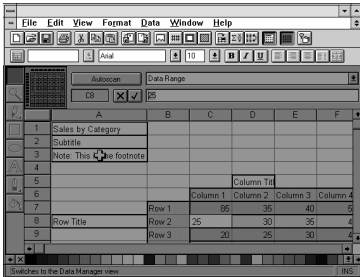

The entire top area is highlighted.

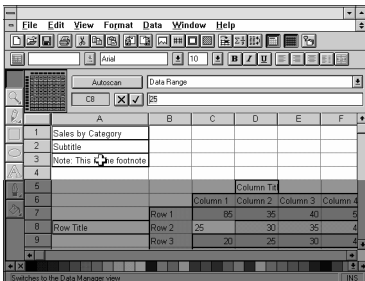

To extend the highlight downwards, press the DOWN Arrow.

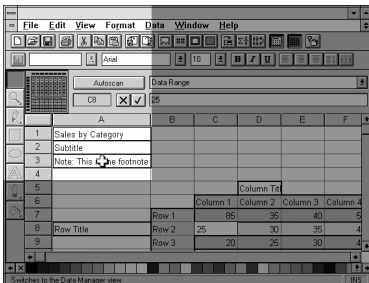

To reduce the highlight to the left, press the LEFT Arrow.

Example 2 :

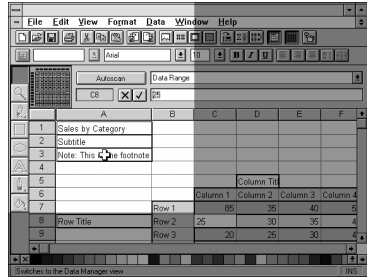

Most of the left part of the screen is highlighted.

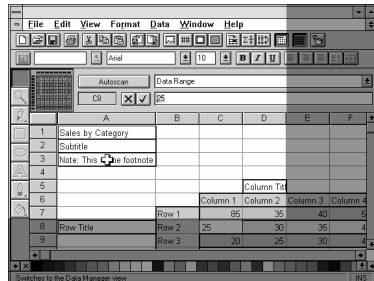

To extend the highlight to the right, press the RIGHT Arrow.

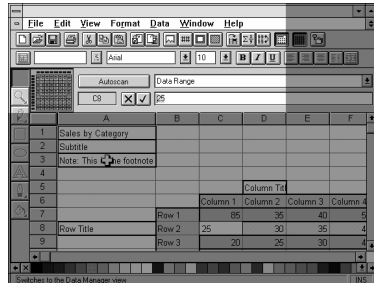

To reduce the highlight upwards, press the UP Arrow.

Different Types of Zoom

The **AVerKey300** provides 4 types of zoom : *Normal Zoom*, *AVerMedia Area Zoom*, *AVerMedia Spot-Zoom*, and *AVerMedia Pointer-Zoom*.

Normal Zoom

Normal Zoom allows you to zoom in (200%) the computer screen on TV display. Simply press the **ZOOM** button on the remote control.

You can move (pan) around freely to any part of the screen. Press the **PAN/POS** button to change to PAN mode. Then, press the Up, Down, Left, and Right Arrows, which are the **Positioning and Movement Control** buttons, to move around the zoomed image.

AVerMedia Area Zoom

This function divides your screen into 9 parts and allows you to select the desired part to zoom through the available buttons on the remote control.

The directional buttons on the remote corresponds to 9 parts of your screen :

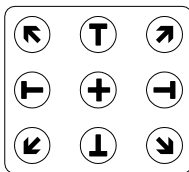

*Directional Buttons
on the Remote Control*

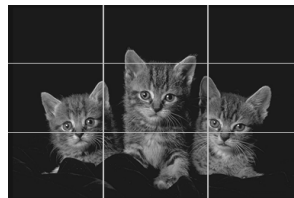

9 Parts of the Screen

Choose which part you want to zoom, and then press one of the 9 directional buttons on the remote that corresponds to that area.

Example :

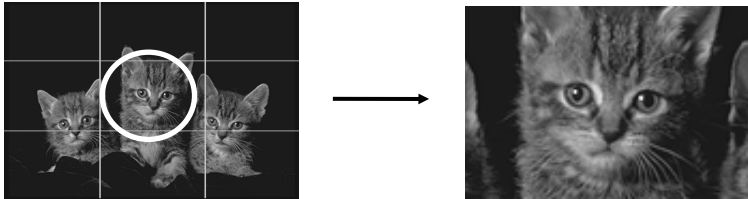

To pan around the zoomed area, press the **PAN/POS** button to change to PAN mode. Then, press the Up, Down, Left, and Right Arrows, which are the **Positioning and Movement Control** buttons, to move around the zoomed area.

AVerMedia Spot-Zoom

As described earlier in the section, *AVerMedia Spot*, under *Special Highlighting Functions*, you can highlight a certain area in your presentation by pressing the **SPOT** button.

After pressing the **SPOT** button, press **ZOOM** if you want to enlarge the highlighted area inside the colored frame. (Refer to the figure on the next page.)

To shift the focus of the zoomed area, press the Up, Down, Left, and Right Arrows, which are the **Positioning and Movement Control** buttons.

Note: This function is not supported under 1280 x 1024 and above.

AVerMedia Spot-Zoom Function

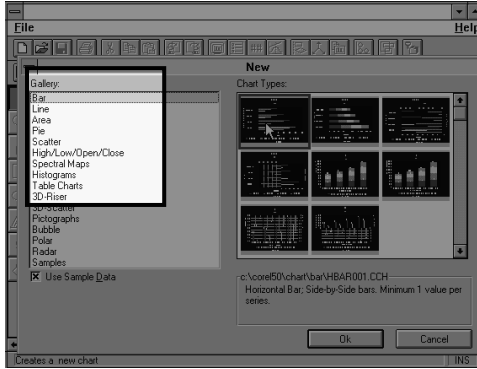

*Press the **SPOT** button to highlight an area.*

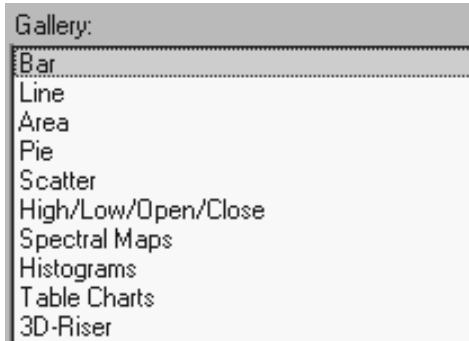

*Then, press the **ZOOM** button to enlarge the highlighted area.*

AVerMedia Pointer-Zoom

After you press the **POINTER** button to point on a key area in your presentation screen, press the **ZOOM** button to magnify the area where you are pointing to.

Note: AVerMedia Spot-Zoom and Pointer-Zoom functions are not supported for screen resolutions 1280 x 1024 and above.

CHAPTER 4

TROUBLESHOOTING

This chapter provides many useful tips on how to solve common problems while using the **AVerKey300**.

There is no picture on my TV.

1. Check all the connectors again as shown in this manual.
2. Check your TV remote control on/off switch and channel setting.
3. Verify the setting of the Composite Input or S-VHS Input of your TV set.
4. If you are using a SCART connector, check the SCART input of your TV set.
5. If you are using a notebook, you may have to switch to external VGA mode. (Refer to your notebook's manual.)
6. As specified by IBM, some systems may require that the monitor is present and connected when the system is powered up.
7. If you are using the **AVerKey300** on the Macintosh, you must have a Macintosh monitor or *Dummy Terminators* connected.

When the signal runs through a VCR, there is no picture on the TV.

1. Check your TV/VCR input channel setting.
2. If your TV and VCR are connected to an AV Amplifier, please check the input/output selection.

I have set up the AVerKey300 and checked all the connections as specified in the manual, but I can only get a picture on the VGA monitor, not on the TV screen.

AVerKey300 is in the “Ready” mode once power is connected. You need to switch **AVerKey300** “ON”, either from the remote control or from its touch button panel to display both VGA and VIDEO.

The picture on my TV is distorted.

1. Before doing any adjustments, reset all the picture attributes to the factory default setting using the “Reset” button on the remote control.
2. Each VIDEO display device is slightly different from another. Use the Panning Control of **AVerKey300** to adjust the picture.
3. Use the Brightness and Sharpness picture attributes controls on the remote control to reduce the distortion.

The picture on my TV is all messed up.

1. When using **AVerKey300** with the Macintosh, up to 1600 x 1200 can be supported.
2. When using **AVerKey300** with IBM PC compatible computers, screen resolutions up to 1600 x 1200 (horizontal frequency less than 108.4KHz) is supported.

There is no image on both my Macintosh monitor and TV.

When you turn on the Macintosh computer, it will first auto-detect the type of monitor you have. During auto-detection, there won't be any display on your Macintosh monitor. To avoid this problem, connect your Macintosh computer, monitor and all the necessary cables to the **AVerKey300** first before you power on your Macintosh computer.

Appendix

SUPPORTED Display Modes

The reference table below lists the various display resolutions which the **AVerKey300** can support.

| Computer / Operating System | Display Resolution | Maximum Vertical Frequency | Maximum Horizontal Frequency | |
|-----------------------------|--------------------|----------------------------|------------------------------|-----------|
| IBM PC DOS/V | 720 × 400 | 60 Hz | 31.5 KHz | |
| | | 640 × 480 | 60 Hz | 31.5 KHz |
| | | | 72 Hz | 37.9 KHz |
| | | | 75 Hz | 37.5 KHz |
| | | | 85 Hz | 43.3 KHz |
| | | | 90 Hz | 47.9 KHz |
| | | | 100 Hz | 52.2 KHz |
| | 800 × 600 | 120 Hz | 61.79 KHz | |
| | | 56 Hz | 35.1 KHz | |
| | | 60 Hz | 37.9 KHz | |
| | | 72 Hz | 48.1 KHz | |
| | | 75 Hz | 46.9 KHz | |
| | | 85 Hz | 53.7 KHz | |
| | | 90 Hz | 57.0 KHz | |
| | | 100Hz | 62.5 KHz | |
| | | 1024 × 768 | 120 Hz | 77.17 KHz |
| | | | 60 Hz | 48.4 KHz |
| | 70 Hz | | 56.5 KHz | |
| | 75 Hz | | 60 KHz | |
| | 85 Hz | | 68.57 KHz | |
| | 1152 × 864 | 100 Hz | 81.42 KHz | |
| 120 Hz | | 98.78 KHz | | |
| 60 Hz | | 53.68 KHz | | |
| 75 Hz | | 67.47 KHz | | |

| Computer / Operating System | Display Resolution | Maximum Vertical Frequency | Maximum Horizontal Frequency |
|------------------------------------|-------------------------------------|--|--|
| | 1280 × 960 1280 × 1024 | 75 Hz 60 Hz 75 Hz 85 Hz 100 Hz | 75.16 KHz 63.96 KHz 80 KHz 91.30 KHz 108.4 KHz |
| | 1600 × 1200 | 60 Hz 75 Hz 85 Hz | 75 KHz 93.8 KHz 106.3 KHz |
| NEC PC9821 | 640 × 400 | 56 Hz | 24.8 KHz |
| NEC PC9801 | 640 × 480 | 60 Hz | 31.5 KHz |
| Macintosh | 512 × 384 640 × 480 800 × 600 | 60 Hz 120 Hz 56 Hz 60 Hz 85 Hz | 24.5 KHz 35 KHz 37.861 KHz 37.879 KHz 53.7 KHz |
| | 832 × 624 1024 × 768 | 75 Hz 75 Hz 85 Hz 120 Hz | 49.7 KHz 60 KHz 68.57 KHz 60 KHz |
| | 1152 × 874 1280 × 1024 | 75 Hz 75 Hz 85 Hz | 68.7 KHz 79.98 KHz 91.15 KHz |
| | 1600 × 1200 | 75 Hz 85 Hz | 93.96 KHz 100 KHz |

LIMITED WARRANTY

AVerMedia TECHNOLOGIES, Inc. warrants this product to be free of defects resulting from faulty manufacture or components under the following terms :

WARRANTY LENGTH

Labor is warranted for (1) one year from the date of purchase.

Parts are warranted for (1) one year from the date of purchase.

Replacement products will be warranted for the remainder of the one year warranty period or (30) thirty days, whichever is longer.

WHO IS PROTECTED

This warranty is enforceable only by the first consumer purchaser.

WHAT IS AND IS NOT COVERED

Except as specified below, this warranty covers all defects resulting from faulty manufacturing of this product. The following are not covered by the warranty.

1. Any product on which the serial number has been defaced, modified, or removed.
2. Damage, deterioration, or malfunction resulting from :
 - A. Accident, abuse, misuse, neglect, fire, water, lightning, or other acts of nature, commercial or industrial use, unauthorized product modification, or failure to follow instructions included with the product.
 - B. Misapplication of service by someone other than the manufacturer's representative.
 - C. Any shipment damages. (Claims must be made with carrier.)
 - D. Any other cause which does not relate to a product defect.
3. Cartons, cases, batteries, cabinets, tapes, or accessories used with product.
4. AVerMedia does not warrant that this product will meet your requirements; it is your responsibility to determine the suitability of this product for your purpose.

WHAT WE WILL AND WILL NOT PAY FOR

We will pay labor and material expenses for covered items. However, we will not pay for the following :

1. Removal or installation charges.
2. Shipping charges.
3. Any incidental charges.

EXCLUSION OF DAMAGES

The manufacturer's sole obligation and liability under this warranty is limited to the repair or replacement of a defective product at our option. The manufacturer shall not, in any event, be liable to the purchaser or any third party for any incidental or consequential damage (including, but not limited to, damages resulting from interruption of service and loss of business) or liability in tort relating to this product or resulting from its use or possession.

LIMITATIONS OF IMPLIED WARRANTIES

There are no other oral or written warranties, expressed or implied, including but not limited to those of merchantability or fitness for a particular purpose. Any implied warranties are limited in duration to one year from the date of purchase.

STATE LAW AND YOUR WARRANTY

This warranty gives you specific legal rights, and you may also have other rights granted under state law. These rights vary from state to state.

CONTACT INFORMATION

www.avermedia.com