

# X30i

## User Manual





## WARNING

ALWAYS FOLLOW SAFETY PRECAUTIONS

NEVER climb, sit  
or stand on the cart.



ONLY ADULTS should  
move the cart.



To reduce risk  
of electric shock  
ONLY use indoors.

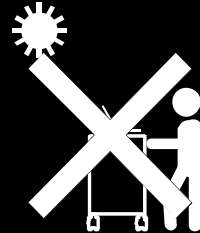

### ⚠ CAUTION

This cart is intended for use only with loading as indicated. Use with loads greater than indicated may result in instability causing possible injury.

≤ 44.09 lbs (20kg)

≤ 59.53 lbs (27kg)

≤ 59.53 lbs (27kg)

≤ 59.53 lbs (27kg)

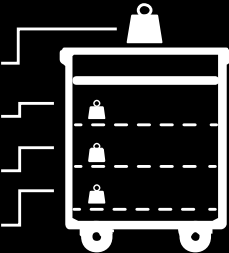

Please place the devices from the bottom to the top shelf to avoid the tilting.

- Death or serious injury may occur when children climb on audio and/or video equipment furniture. A remote control or toys placed on the furnishing may encourage a child to climb on the furnishing and as a result the furnishing may tip over on to the child.
- Relocating audio and/or video equipment to furniture not specifically designed to support audio and/or video equipment may result in death or serious injury due to the furnishing collapsing or over turning onto a child.

## CAUTION!

- **DO NOT** allow anyone to sit, stand or climb on the cart.
- **DO NOT** lift the cart.
- **DO NOT** block the ventilation holes used for air circulation.
- **DO NOT** overload objects on the cart shelves. (Work platform maximum loading = 20kg / 44.09lbs; each shelf maximum loading = 27kg / 59.53lbs).
- **DO NOT** put any devices that the weight is over the maximum loading weight on top of cart.
- When moving the cart, **DO NOT** put any devices (ex: TV, Monitor, Documents camera...etc.) on top of cart.
- No TV/monitor is to be used on top of cart.
- Before moving the cart, disconnect the power from the wall outlet.
- While moving the cart, make sure the power cord is secured and tightly wrapped.

## **FCC NOTICE (Class A)**



NOTE: This equipment has been tested and found to comply with the limits for a Class A digital device, pursuant to part 15 of the FCC Rules. These limits are designed to provide reasonable protection against harmful interference when the equipment is operated in a commercial environment. This equipment generates, uses, and can radiate radiofrequency energy and, if not installed and used in accordance with the instruction manual, may cause harmful interference to radio communications. Operation of this equipment in a residential area is likely to cause harmful interference in which case the user will be required to correct the interference at his own expense.

FCC Caution: Any changes or modifications not expressly approved by the party responsible for compliance could void the user's authority to operate this equipment.

This device complies with part 15 of the FCC Rules.

Operation is subject to the following two conditions:

- (1) This device may not cause harmful interference, and
- (2) this device must accept any interference received, including interference that may cause undesired operation.

## **DISCLAIMER**

No warranty or representation, either expressed or implied, is made with respect to the contents of this documentation, its quality, performance, merchantability, or fitness for a particular purpose. Information presented in this documentation has been carefully checked for reliability; however, no responsibility is assumed for inaccuracies. The information contained in this documentation is subject to change without notice.

In no event will AVer Information Inc. be liable for direct, indirect, special, incidental, or consequential damages arising out of the use or inability to use this product or documentation, even if advised of the possibility of such damages.

## **TRADEMARKS**

"AVer" is a trademark owned by AVer Information Inc. Other trademarks used herein for description purpose only belong to each of their companies.

## **COPYRIGHT**

©2018 AVer Information Inc. All rights reserved.

All rights of this object belong to AVer Information Inc. Reproduced or transmitted in any form or by any means without the prior written permission of AVer Information Inc. is prohibited. All information or specifications are subject to change without prior notice.



The mark of Crossed-out wheeled bin indicates that this product must not be disposed of with your other household waste. Instead, you need to dispose of the waste equipment by handing it over to a designated collection point for the recycling of waste electrical and electronic equipment. For more information about where to drop off your waste equipment for recycling, please contact your household waste disposal service or the shop where you purchased the product.

## **Contact Information**

### **Global**

AVer Information Inc.

[www.aver.com](http://www.aver.com)

8F, No.157, Da-An Rd., Tucheng

Dist.,

New Taipei City

Taiwan

Tel: +886-2-2269-8535

### **USA**

AVer Information Inc.

668 Mission Ct

Fremont, CA 94539

[www.averusa.com](http://www.averusa.com)

Toll-free: 1(877)528-7824

Local: 1(408)263-3828

Support.usa@aver.com

# Contents

Package Contents .....	1
Dimensions .....	1
Diagram .....	2
LED Indicators .....	3
Secure the Cart.....	4
Door Lock .....	4
Cable Management .....	6
Charging Cart .....	8
Adaptive Intelligent Charging System.....	9
Troubleshooting .....	10
Specifications.....	11
Service and Warranty .....	12

# Package Contents

The following items are included in the package. Please check if each item is available before using.

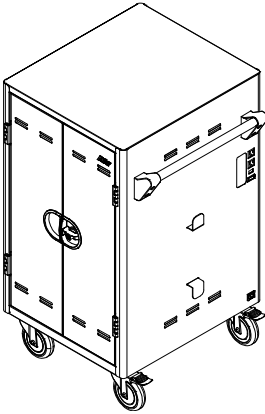

**X30i Cart**

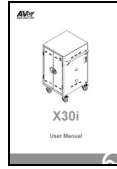

**User Manual**

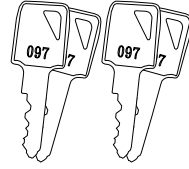

**Door key x4**



**Power cable**

# Dimensions

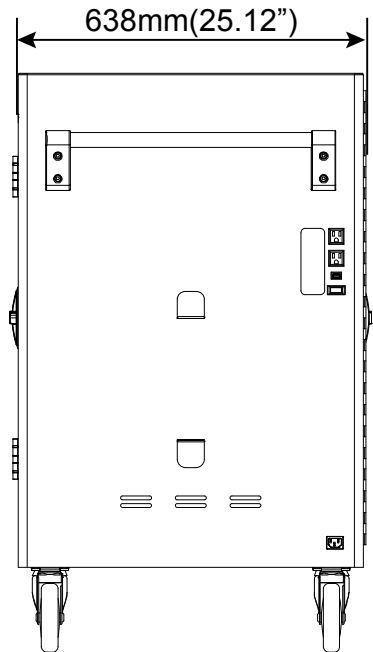
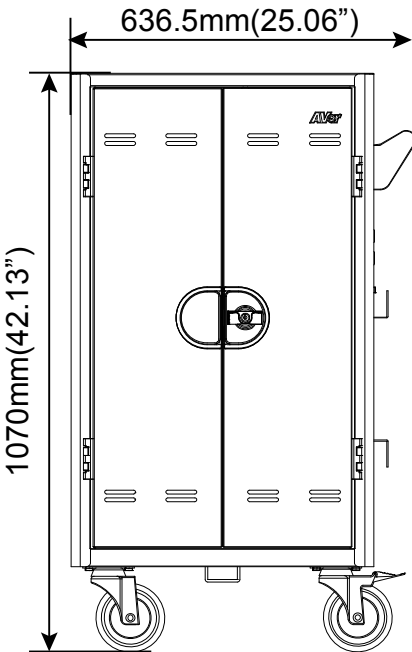

# Diagram

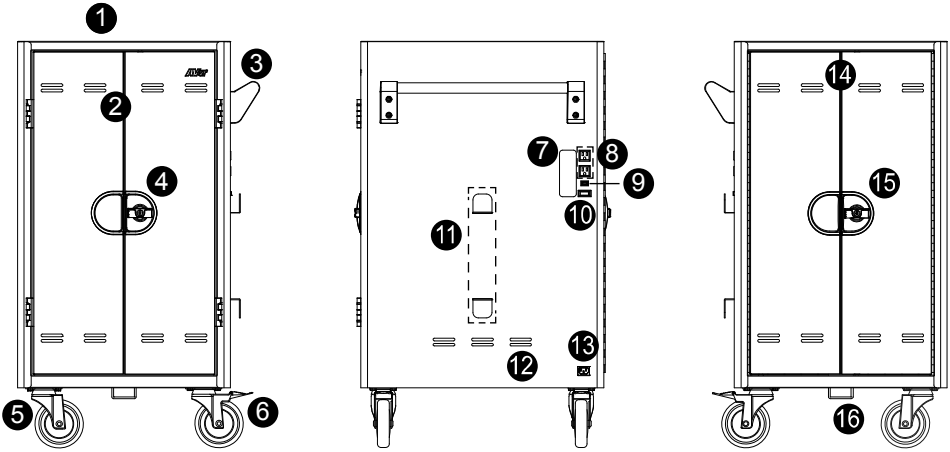

Front	Side	Back
1. Work platform	7. LED panel	14. Ventilation holes
2. Ventilation holes	8. Auxiliary outlets	15. Door lock
3. Handle	9. USB firmware upgrade port (not for charging or storage)	16. Security hook
4. Door lock	10. Power switch	
5. 5" caster	11. Power cable wrap brackets	
6. 5" lockable caster	12. Ventilation holes	
	13. Power inlet	



# LED Indicators

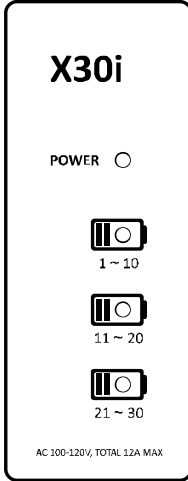

LED	Status
Power x1	<ol style="list-style-type: none"> <li><b>Solid Green:</b> ON</li> <li><b>Flashing Green / Orange / Red:</b> Abnormal situation ( please check below table for details )</li> </ol>
Device Status x3	<ol style="list-style-type: none"> <li><b>All Off:</b> Power draw is less than 1A or all devices are fully charged</li> <li><b>Off:</b> No Charging</li> <li><b>Solid Blue:</b> Charging</li> </ol>

LED	Status	Description
Power	<b>Flashing Green and Orange:</b> Power Overload (AUX is turned off and charging is still available)	<p><b>Situation:</b> The total power draw of auxiliary outlet and charging zone caused power overloaded.</p> <p><b>Solution:</b> Power off, remove anything connected to auxiliary outlets and power back on.</p>
	<b>Flashing Orange:</b> Power Overload	<p><b>Situation:</b> Power draw of auxiliary outlet or one of charging zone caused power overloaded.</p> <p><b>Solution:</b> Check whether there is any high power devices such as heater...etc., connected to auxiliary outlet or charging zone.</p>
	<b>Solid Orange:</b> Short Protection	<p><b>Solution:</b> Please check devices which connected to auxiliary outlet and charging zone for it might have problems.</p>
	<b>Flashing Red:</b> Abnormal Failure	<p><b>Solution:</b> Contact Support (Support.usa@aver.com)</p>

# Secure the Cart

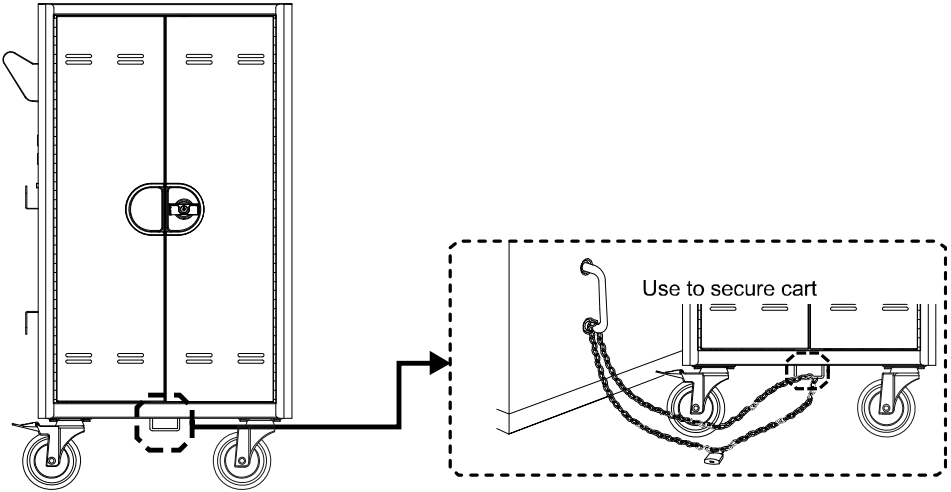

# Door Lock

- Unlock the door

① Use key to unlock the door.

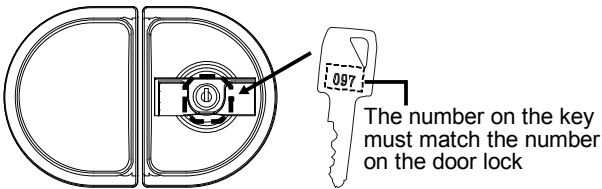

② Turn the door lock to vertical position to open the door.

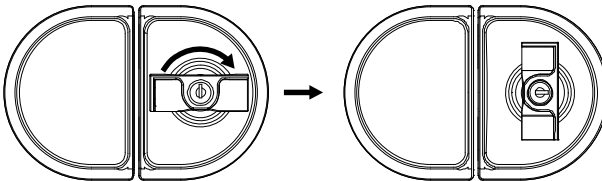

■ Lock the door

To lock the door, close the door and turn the door lock back to horizontal position.

Then, use the key to lock the door.

For more security, use padlock to double secure the door.

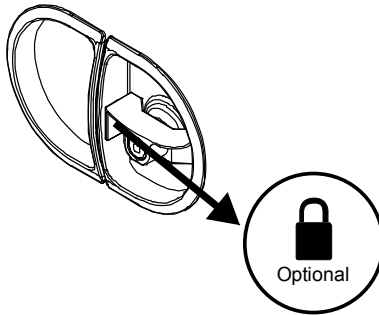

**[Note]** The shackle dimension of front and back doors are limited to Ø8mm (0.31”).

# Cable Management

## Back

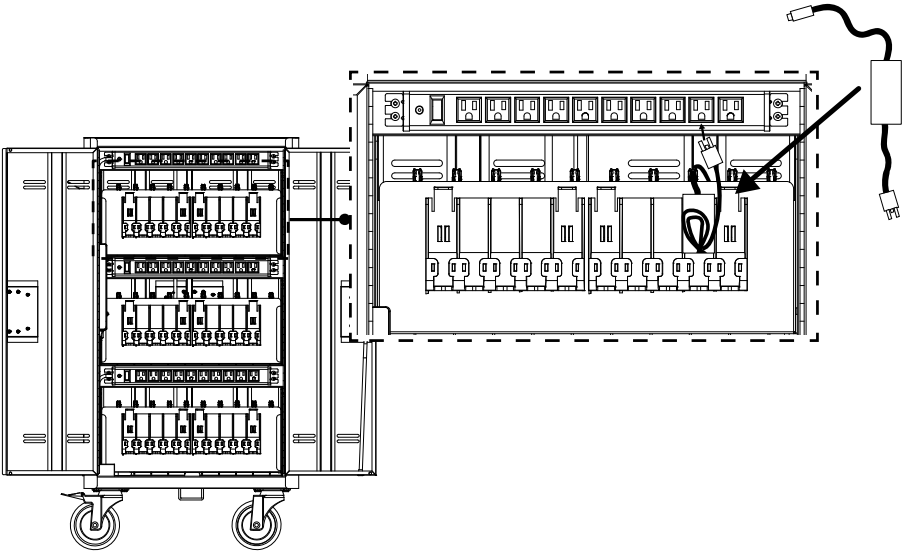

1. Open the rear door.
2. Bundle the DC power cord with cable tie or zip-tie(not supplied) and leave proper length for connecting to the device.
3. Place the power adapter in to the individual adapter compartment.
4. Pass the DC-end of the adapter cable to the front of the cart through the space provided.
5. Plug-in the AC-end power cord to the corresponding power AC socket.

### [Note]

- a. It is recommended to use cable ties (optional) to secure and manage cables.
- b. It is recommended to allocate 2 persons for efficient device cabling.

## Front

1. Open the front doors.

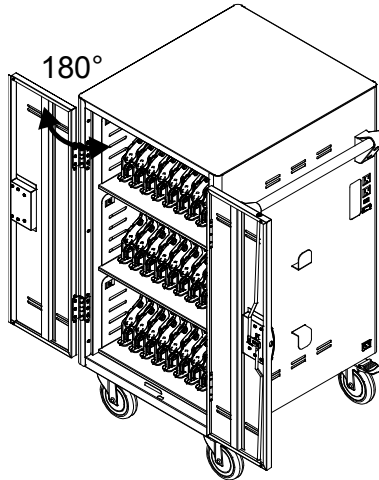

2. Release the cable clamp by pulling locking feature (A).
3. Route the adaptor DC-end cable. Along with the V-shape routing groove.

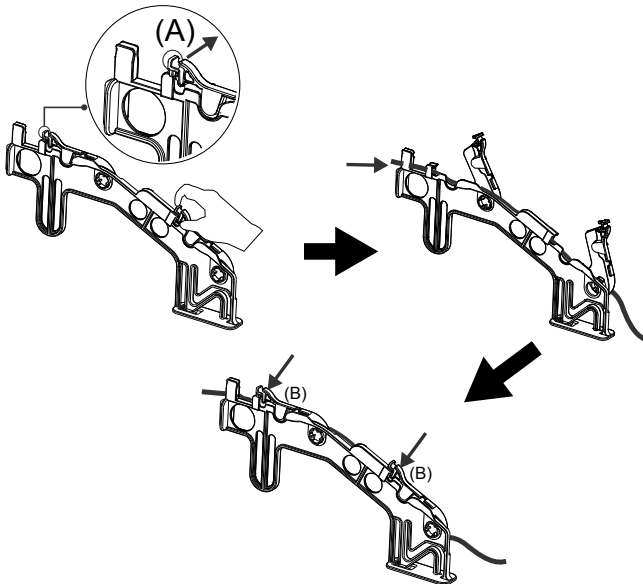

4. Snap the locking piece (B) to firmly secure the DC-end cable.
5. Place the mobile device into the bay.
6. Plug in the DC-connector to the mobile device.

# Charging Cart

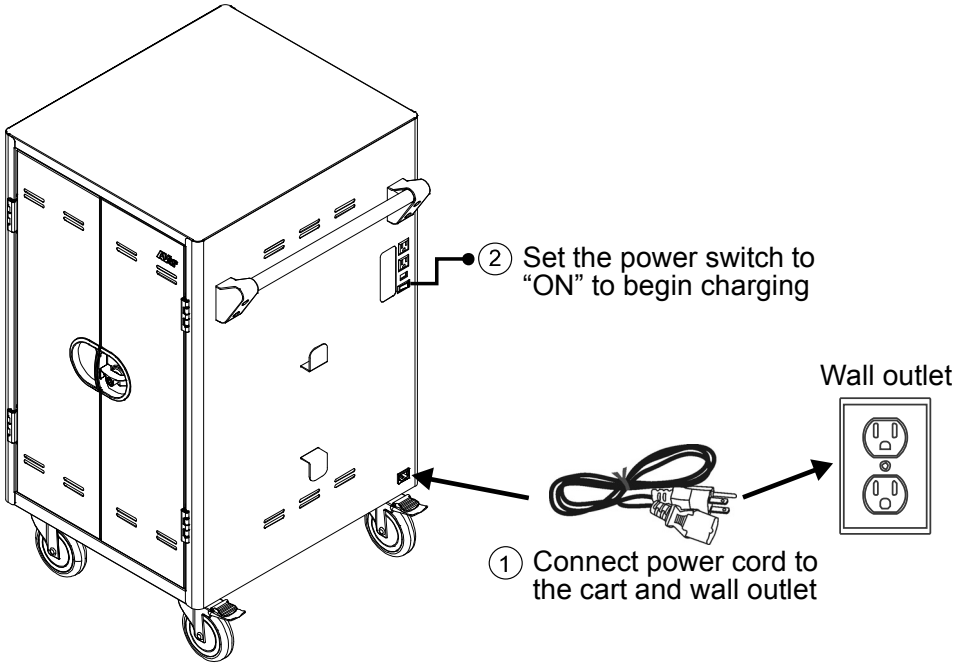

## [Note]

- Set the power switch to the **OFF** position before plugging the cart to wall outlet.
- Auxiliary outlet and power inlet type may vary as they are country dependent.

# Adaptive Intelligent Charging System

30 bays for X30i are divided into 3 zones (10 bays for each zone).

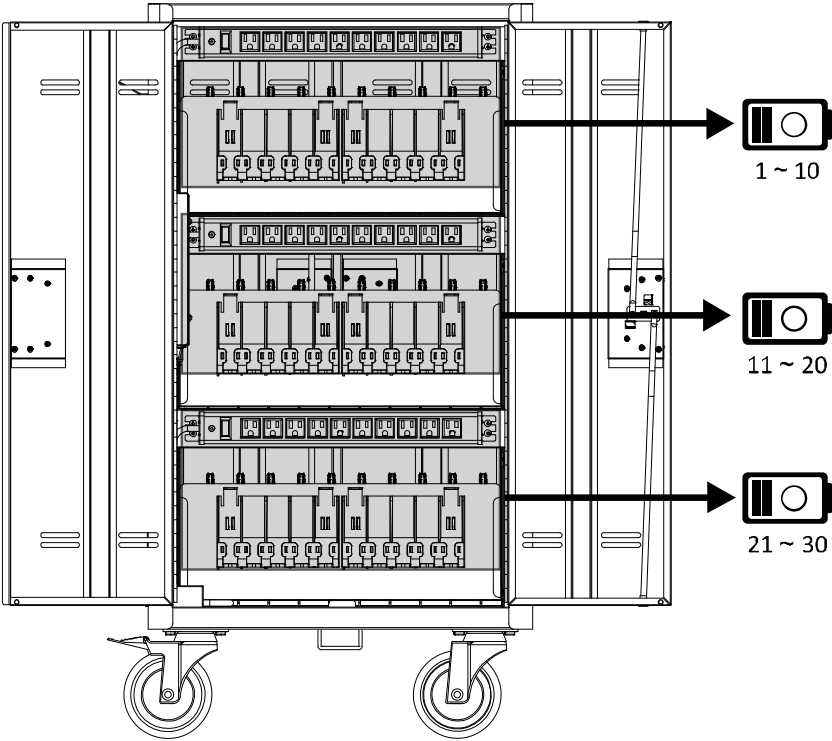

# Troubleshooting

## **Q: Why are all of my devices plugged in but not charging?**

A: 1. Make sure power cords are undamaged.

2. Make sure power cords are firmly inserted into the available socket with stable current.
3. Make sure the power plug and current consumption are compliant with your country specification standards.
4. Make sure the cart is plugged into a dedicated wall outlet (not shared with other electronics such as a printer)
5. Make sure the main power switch of the cart as well as the individual power switches on each power strip are set to the ON or RESET position.
6. Remove any electronics plugged into auxiliary and power cycle the cart.

## **Q: My cart's main power cord or cart components are damaged. Are they covered under warranty?**

A: It will be covered if within warranty period and our warranty policy is 10 year warranty on the cart and 5 years warranty on the electrical components.

## **Q: How do I know if my devices will exceed more than the allotted current?**

A: Have a qualified electrician verify the current consumption of your devices. Perform the test with devices installed and batteries discharged.

## **Q: When I plug in the device it trips the circuit breaker. What is wrong?**

A: You may have other equipment or appliances sharing the same circuit that is causing a circuit overload. Have a qualified electrician check that adequate power is available in the circuit.



# Specifications

<b>Model</b>	X30i
<b>Capacity</b>	30 (three shelves, 10 bays per shelf)
<b>Supported Devices</b>	Mobile devices up to 15"
<b>AUX Outlets</b>	2
<b>LEDs Status Indicators</b>	Power LED: Red/Green Status LED (x3): Solid Blue: Charging
<b>Charging Type</b>	AC Adaptive Intelligent Charging
<b>Power Specification</b>	AC IN: 100-120V ~ 50/60Hz, 12A Power Strip: 100-120V ~ 50/60Hz, 12A Outlet: 100-120V ~ 50/60Hz, 12A
<b>Security</b>	Front Doors/Rear Door: 3-point locking mechanism with padlock hole. <b>[Note]</b> Padlock is not included in the package
<b>Casters</b>	Four 5" casters: two are lockable
<b>Intelligent Charging</b>	Yes
<b>Top Surface(work platform)</b>	20kg (44.09lbs)
<b>Shelf Support Weight(ea.)</b>	27kg (59.53lbs)
<b>Adapter Shelves(ea.)</b>	3kg(6.6lbs)
<b>Working Temperature</b>	0°~30°C
<b>Working RH%</b>	10%~90%
<b>Storage Temperature</b>	-40°C~60°C
<b>Storage RH%</b>	5%~95%
<b>Warranty</b>	10 years cart and tray 5 years electrical components
<b>Cart Dimensions (W x D x H)</b>	636.50(W) x 638(D) x 1070(H)mm 25.06"(W) x 25.12"(D) x 42.13"(H)

<b>Model</b>	X30i
<b>Slot Dimensions (W x D x H)</b>	36(W)x 400(D) x 270(H) mm 1.42"(W) x 15.75"(D) x 10.63"(H)
<b>Weight without Devices</b>	61 Kg (134 lbs)

## Service and Warranty

All of our products come with a quality and safety assurance.

For customers located in North America, please visit the AVer USA support site for comprehensive RMA, Warranty, and Service information:

<http://averusa.com/classroom-technology/support/>

For customers located outside North America, please visit AVer Global support site:

<http://www.aver.com/>