



AVer CP series

65"

User Manual



FCC NOTICE (Class B)



This device complies with Part 15 of the FCC Rules. Operation is subject to the following two conditions: (1) this device may not cause harmful interference, and (2) this device must accept any interference received, including interference that may cause undesired operation.

Federal Communications Commission Statement

NOTE- This equipment has been tested and found to comply with the limits for a Class B digital device, pursuant to Part 15 of the FCC Rules. These limits are designed to provide reasonable protection against harmful interference in a residential installation. This equipment generates uses and can radiate radio frequency energy and, if not installed and used in accordance with the instructions, may cause harmful interference to radio communications. However, there is no guarantee that interference will not occur in a particular installation. If this equipment does cause harmful interference to radio or television reception, which can be determined by tuning the equipment off and on, the user is encouraged to try to correct the interference by one or more of the following measures:

- Reorient or relocate the receiving antenna.
- Increase the separation between the equipment and receiver.
- Connect the equipment into an outlet on a circuit different from that to which the receiver is connected.
- Consult the dealer or an experienced radio/television technician for help.

Class B (EMC)



This product is herewith confirmed to comply with the requirements set out in the Council Directives on the Approximation of the laws of the Member States relating to Electromagnetic Compatibility Directive 2014/30/EU.

DISCLAIMER

No warranty or representation, either expressed or implied, is made with respect to the contents of this documentation, its quality, performance, merchantability, or fitness for a particular purpose. Information presented in this documentation has been carefully checked for reliability; however, no responsibility is assumed for inaccuracies. The information contained in this documentation is subject to change without notice.

In no event will AVer Information Inc. be liable for direct, indirect, special, incidental, or consequential damages arising out of the use or inability to use this product or documentation, even if advised of the possibility of such damages.

TRADEMARKS

“AVer” is a trademark owned by AVer Information Inc. Other trademarks used herein for description purpose only belong to each of their companies.

COPYRIGHT

©2017 AVer Information Inc. All rights reserved.

All rights of this object belong to AVer Information Inc. Reproduced or transmitted in any form or by any means without the prior written permission of AVer Information Inc. is prohibited. All information or specifications are subject to change without prior notice.

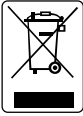

The mark of Crossed-out wheeled bin indicates that this product must not be disposed of with your other household waste. Instead, you need to dispose of the waste equipment by handing it over to a designated collection point for the recycling of waste electrical and electronic equipment. For more information about where to drop off your waste equipment for recycling, please contact your household waste disposal service or the shop where you purchased the product.

CONTENTS

Introduction	1
Hardware Introduction	2
Front Side	2
Back Side.....	2
Control Panel	3
Connection Panel 1	4
Connection Panel 2	5
Connection Panel 3	6
Remote Controller.....	8
Using Remote Controller.....	10
Mounting	11
Ventilation.....	11
Start up AVer CP System.....	13
Power on.....	13
Power off.....	14
Thermal Shutdown.....	14
Calibration.....	15
OPS Installation	17
Using The AVer CP System.....	18
Main Screen.....	18
Toolbar	19
Task Manager	22
Select Signal Source.....	23
Single Source Mode Setting.....	24
Whiteboard Mode	25
New Page/Overview/Delete all.....	25
Settings	27
Pen.....	28
Highlighter	29
Eraser.....	30

Go Back	31
Screen Capture	32
Print, Clear and Freeze Screen	33
Gallery	34
Copy Files	36
Kids Safety Lock	38
ECO Mode	39
Specification	40
Serial Port Control	40
VGA Signal Input	43
Multimedia Format Support.....	44
Common Faults and Solutions	44
Technical Specification.....	48
Care and Maintenance	49

Safety Instruction

For your safety, please read the following instruction before you use the product. Serious injury or property loss may be caused by improper operations. Do not try to repair the product by your own.



WARNING



Disconnect the product from power supply immediately if major failures occur.

The major failures include the following:

- Smoke, peculiar smell or abnormal sound is discharged from the product.
- No image or sound is displayed, or the image error occurs.
- Where the mains plug or an appliance coupler is used as the disconnect device the disconnect device shall remain readily operable.

In the preceding scenarios, do not continue to use the product, disconnect power supply immediately and contact professional staff for troubleshooting.

The socket-outlet shall be installed near the equipment and shall be easily accessible.



Do not drop liquid, metal or combustible into the product.

- If any liquid or metal is dropped into the product, power off the product and disconnect power supply, then contact professional staff for solutions.
- Pay attention to the children when they are close to the product.

Do not damage the power cable.

- Do not damage, change, wind, bend, heat or drag the power cable forcibly.
- Do not put weights (such as the product itself) on the power cable.
- Do not drag the cable forcibly when you pull out the power plug. If the power cable is damaged, please contact the local distributor to repair or replace it.
- The power cable in the accessory box is for this product only. Don't use it on other devices.



WARNING

Put the product on a stable surface.

An unstable surface includes and does not limit to an inclined plane, a shaky stand, desk or platform, which might cause the turnover and damage.

Use the battery correctly.

- Galvanic corrosion, electric leakage and even fire may be caused by improper battery usage.
- It is recommended to use the designated type of battery and install the battery by correct electrodes (positive and negative electrodes).
- Do not install and use new battery together with the used one.
- Take out the battery if the remote control is not used for a long period.
- Do not expose the battery under overheated environments such as sunlight and firing.
- Dump the used battery based on local regulations.



Do not open the cover or change the product by your own.

High voltage components are installed in the product. When you open the cover, high voltage, electric shock or other dangerous situations may occur. If inspection, adjustment or maintenance is required, contact the local distributor for help.



Use the specified power supply.

- Do not use any types of power cables other than the one provided with the product to prevent the product from being damaged.
- Use a three-wire socket and ensure that it is properly grounded.
- Pull out the power plug from the socket if the product is not used for a long period.

Before you move the product, disconnect all external connections and separate all toppling preventing devices.

Move the product carefully to prevent it from being hit or squeezed, especially the screen, which may cause injury if broken.



WARNING

Clean the dust and metal on the power plug regularly.

- When you are cleaning, fire or electric shock may be caused if the product is powered on.
- Keep in mind to pull out the power plug before cleaning it by using a dried cloth.



Do not put items on the top of the product.

- Do not put items, such as a container for liquid (a vase, flowerpot, cosmetics or liquid medicine), on the top of the product.
- If any water or liquid is spilled on the product, short circuit may occur and cause fire or electric shock.
- Do not tread on the product or hang any items on the product.



Do not install the product in an improper place.

- Do not install the product in humid places, such as the bathroom, the shower room, the place near windows or outdoor environments where experience rain, snow or other harsh weather. The product installation is also required to avoid a place around by hot spring vapor. The preceding environments may cause faults or electric shock under extreme conditions.
- Do not put exposed fire source, such as an ignited candle, on the product.



Pull out the power plug during thunderstorms.

- Do not touch the product when lightning to avoid electric shock.
- Install or place components which power supply voltage is high enough to cause personal injury in places out of the reach of children.



Do not cover or block up any vents on the product.

- The overheated components may cause fire, damage the product and shorten the service life.
- Do not put the venting surface of the product facedown.
- Do not install the product on a carpet or bed clothes.
- Do not use a cloth such as table cloth to cover the product.



WARNING



Do not touch the power cable with wet hands to avoid electric shock.
Altitude during operation (m): less than 5000m



CAUTION



Do not install the product in high temperature environments.

- Do not install the product near heat source, such as the radiator, the heat reservoir, the stove or other heating devices.
- Do not expose the product under sunlight, which may cause high temperature and subsequent faults in the product.



For transport:

- Pack the product for mobility or maintenance by using the cartons and cushioning material provided with the product.
- Vertically move the product during transport. The screen or other components are easily broken if the product is moved by an improper way.



Keep away from the product when you use a radio.

The product design to prevent radio interference complies with the international EMI standard. However, the interference still exists and causes noise in the radio.

- If noise occurs in the radio, try the following solutions.
- Adjust the direction of the radio antenna to avoid the interference from the product.
- Keep the radio away from the product.



CAUTION

Advice for watching:

- Use the product in an environment with comfortable light. It is harmful to your eyes to watch in a too bright or too dark environment.
- Relax your eyes after a period of time for watching.
- When you are watching, the distance which is 3 to 7 times of the display height should be kept, and it is the best distance to protect eyes and prevent eyestrain.
- Adjust the volume to an appropriate level, especially at night.
- Use amplifier equipment as the audio input source with caution. If you must use amplifier equipment, the input power should not exceed the maximum of speaker power. Otherwise, problems occur, such as the speaker is overpowered and damaged.

Introduction

Thank you for choosing our interactive display. As our latest independently developed and produced human-machine interactive product, the interactive display is a multi-functional display for interactive teaching, digital demonstration, multi-media presentation, touch operations and handwriting. They are well designed and produced to meet the needs of education and corporate applications, and provide a user-friendly experience, digital intelligent control as an ideal equipment for schools and companies. You can use your fingers or opaque objects to write, edit and delete any things on the screen.

The product features are as follows:

- Specially designed for teaching and meeting rooms.
- Adopt advanced infrared array scanning and sensing technology, HID driver-free, meaning the product is activated soon after it is powered on.
- Multi-signal sources can be previewed in the window and be switched by touching the screen.
- A special button is set to adjust the brightness automatically with no impact on watching and save up to 50% energy.
- Support front-facing high-power amplifiers.
- When the screen display function is disabled, the product can still play audio to save energy.
- Sense the illumination and brightness automatically to adjust the screen backlight so that the most comfortable screen brightness can be displayed to teachers and students.

Hardware Introduction

Front Side

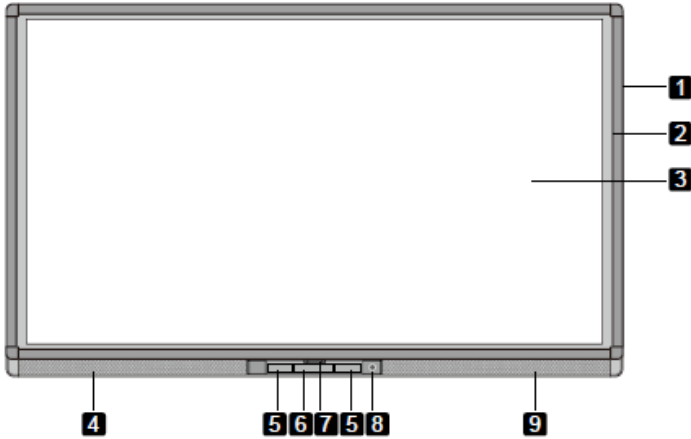

Back Side

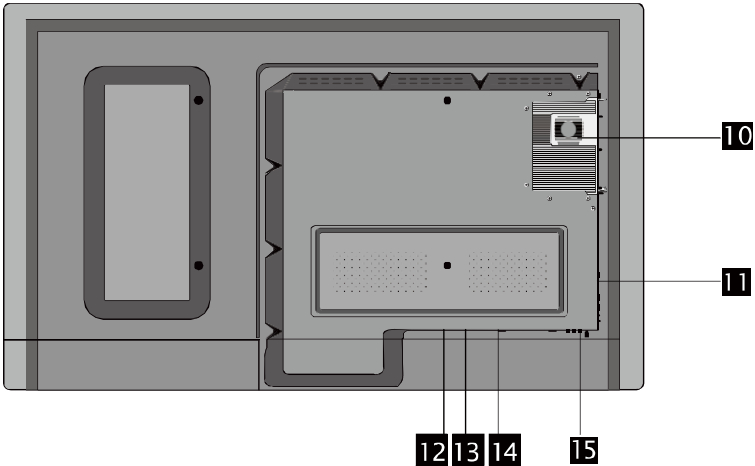

- | | | |
|-----------------------|-----------------------|------------------------|
| 1. Enclosure | 6. Control Panel | 11: Connection Panel 2 |
| 2: Infrared Frame | 7. Front Cover Plate* | 12. Temperature Reset |
| 3: Screen | 8. Power on/off | 13. Rocker Switch |
| 4. Left Loudspeaker | 9. Right Loudspeaker | 14. Power inlet |
| 5. Connection Panel 1 | 10. OPS Port | 15. Connection Panel 3 |

* indicates optional

Control Panel

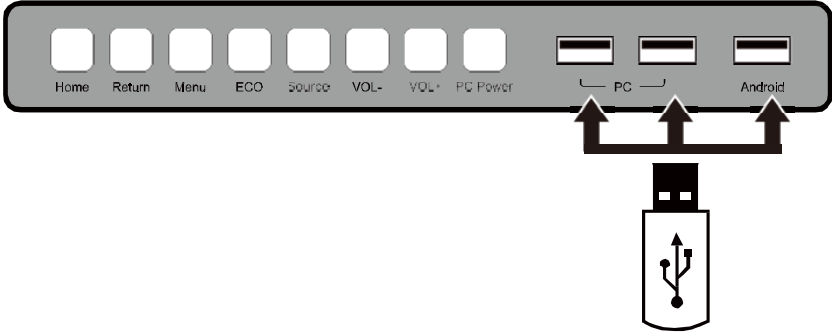

Name	Descriptions
Home	Enter the Android home page.
Return	Return to previous menu.
Menu	Enter the function menu of screen.
ECO	Switch among three modes: energy-saving, automatic, and standard.
Source	Enter the menu to select the signal source.
VOL-	Decrease volume.
VOL+	Increase volume.
PC Power	Power on or off the OPS.
PC	The USB 2.0 and USB 3.0 ports for the OPS.
Android	Android USB port.

Connection Panel 1

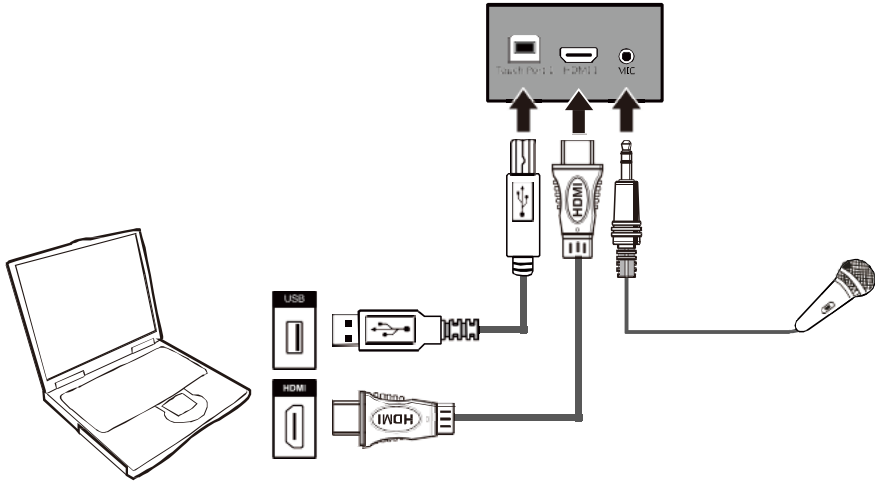

Name	Descriptions
Touch Port 1	PC connecting port 1 for touch control.
HDMI 1	The input terminal 1 for high definition signal, which is used with the Touch Port 1 to operate PC in the way of touch control.
MIC	The external microphone port.

[Note] Touch Port 1 corresponds to HDMI 1, and Touch Port 2 corresponds to VGA In, HDMI 2 and HDMI 3.

Connection Panel 2

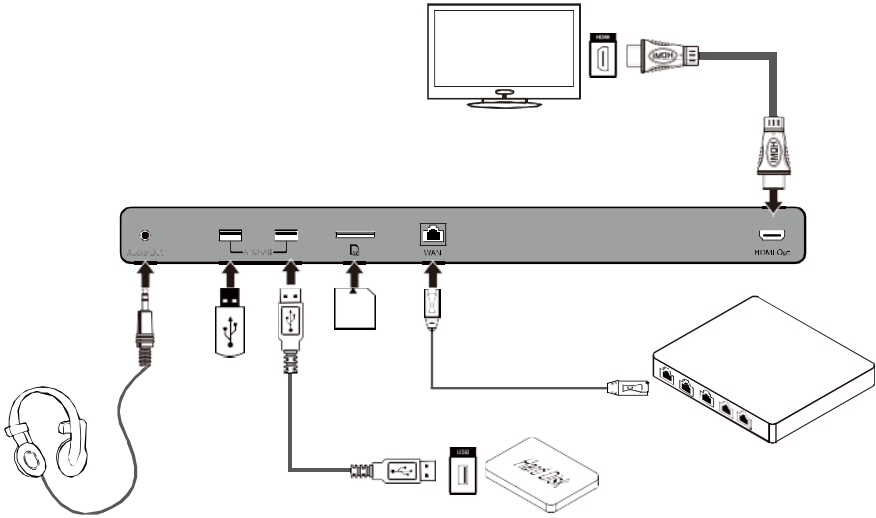

Name	Descriptions
Audio Out	The terminal for external loudspeaker boxes or headphones.
Android	The USB 2.0 and USB 3.0 ports for connecting to the Android system.
SD	The external port for the SD card.
WAN	The port for wide area network, which is used to connect to external network.
HDMI Out	The output terminal for high definition signal, which can transmit the signal to other display equipment with high definition.

Connection Panel 3

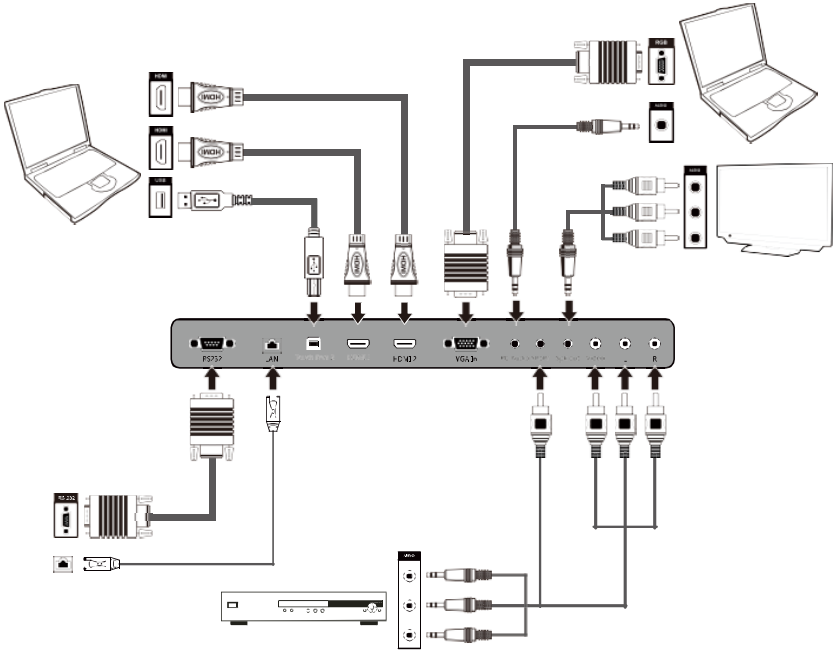

Name	Descriptions
RS232	The input port for series signals, which is used by specific control device of serial port to input serial port protocol in order to control the panel.
LAN	The port for local area network, which is used to connect to internal network.
Touch Port 2	The terminal 2 for touch control signal.
HDMI 3	The input terminal 3 for high definition signal, which is used with the touch port 2 to operate PC in the way of touch control.
HDMI 2	The input terminal 2 for high definition signal, which is used with the touch port 2 to operate a PC in the way of touch control.
VGA In	The VGA port for an external PC, which is used with the touch port 2 to operate the PC in the way of touch control.
PC Audio	The PC Audio is used with the VGA port for an external PC.

Name	Descriptions
YPbPr	The component video terminal, which is used to connect to video devices such as the HD digital signal STB, the satellite receiver, DVD players and other HD displays or TV equipment.
Spk out	Audio and video output terminal.
Video	An array of audio and video input terminals, which are used to input audio and video signal.
L	Video: Video input terminal.
R	L: Left audio input terminal.
	R: Right audio input terminal.

[Note]

- Please use the cable provided with the product to connect to device.
- HDMI 1, HDMI 2 and HDMI 3 are high-definition multimedia ports, which are used to provide home theatre experience with the best quality for consumers by transmitting high-definition, all-digital audio and video. If there is an HDMI port on the external device, you are advised to connect it with the product by using the HDMI cable in order to display better image and sound effect.

Remote Controller

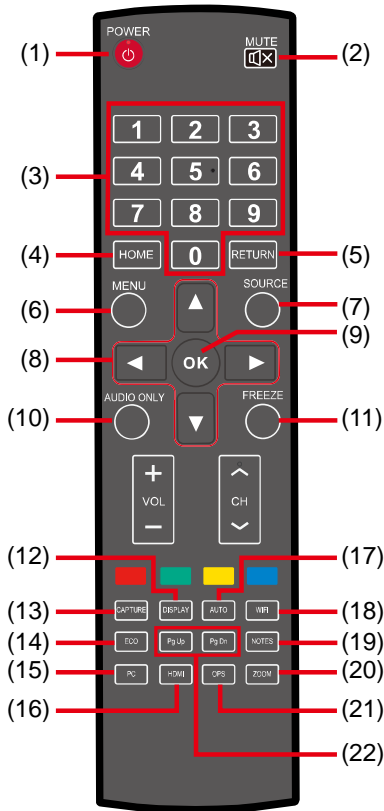

Name	Descriptions
(1)	Power on or standby mode.
(2)	Mute the sound.
(3) Number 0~ 9	TV channel select or numbers enter.
(4) HOME	Open the Android home page.
(5) RETURN	Go back to the main screen or previous menu.
(6) MEMU	Display menu.
(7) SOURCE	Display the list of signal sources.
(8)	Direction buttons

Name	Descriptions
(9) OK	Confirm the selection.
(10) AUDIO ONLY	Enable audio only mode. The screen view will turn to black screen.
(11) FREEZE	Freeze/un-freeze the screen.
(12) DISPLAY	Display the current source data. It won't work in Android platform.
(13) CAPTURE	Snapshot current screen view.
(14) ECO	Change the display mode.
(15) PC	Switch to VGA source.
(16) HDMI	Switch to HDMI source.
(17) AUTO	Adjust screen displaying.
(18) WIFI	Enable/disable WIFI connection.
(19) NOTE	Open whiteboard function. [Note] Only work in Android system.
(20) ZOOM	Switch screen display between 16:9, 4:3, and P2P display mode.
(21) OPS	Switch over to OPS source.
(22) Pg Up/Pg Dn	<ul style="list-style-type: none"> ■ Pg Up: Switch to the previous page on whiteboard software and PPT. ■ Pg Dn: Switch to the next page on whiteboard software and PPT.

Using Remote Controller

The effective area of the remote controller is the vertical distance within 5 meters in front of the product and the area within an angle of 30 degrees from the vertical point to the left and the right.

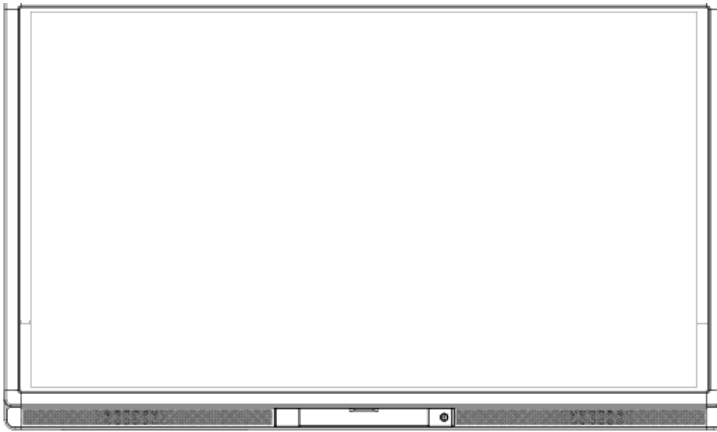

The effective receiving area is about 3 meters with 30° angle from vertical point to the left.



The effective receiving area is about 3 meters with 30° angle from vertical point to the right.



The effective receiving distance is about 5 meters from the front of device.

[Note] To avoid probable faults, please read the following instructions and use the remote controller properly.

- Do not drop or beat the remote controller.
- Do not spill water or other liquid on the remote controller.
- Do not put the remote controller on wet items.
- Do not expose the remote controller under sunlight or put it near overheated source.

Mounting

You can choose the portable or a wall-mounting method according to your needs. The wall mounting can substantially save the space.

If you choose portable mounting, use the mounting rack or support. If you want to use a self-made mounting rack, the bearing capacity of the rack should be at least four times of the display weight. The bearing capacity of the mounting support must be four times of the actual weight of the display to ensure steadiness of the interactive display.

When you choose wall mounted, the bearing capacity of the mounting surface must be at least four times of the weight of the display. When the mounting surface is a wall or ceiling of a building, the wall must be built with solid ricks, concrete or materials of equal intensity. If you need to mount the display on a loose surface such as an old brick wall, wood plank wall, solid wall, metal or non-metal structure wall or a wall with a thick decoration layer, take necessary consolidating measure to ensure that the display is steadily mounted.

Ventilation

Ventilation requirements	Distance to the surface for installation (cm)			
	Left and right sides	Top	Bottom	Back
Nominal power				
Larger than 100 W	10	20	20	20

[Note]

If the product is being mounted inside a wall or a cabinet, in addition to the preceding requirements, the area of ventilation holes at the bottom, top and two sides must be at least 50% of the sealing surface to ensure proper ventilation.

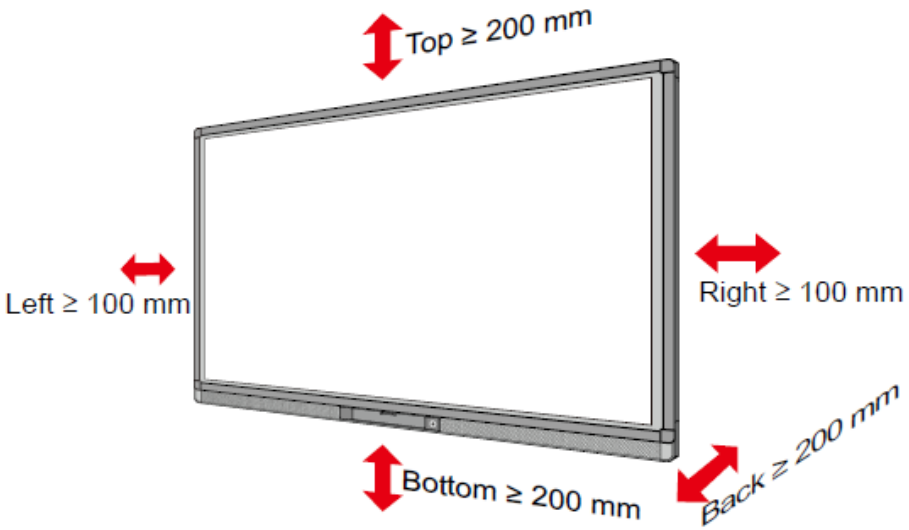

[Note]

- When you install by using the wall mounting method, ensure that you insert the screws into the wall deeper than 10mm.
- Do not block ventilation vents.
- Reference to the CAS 132-2006
- The dimension of the 4 bracket mounting holes in the back panel is VESA MIS-F compliant (600 x 400mm). Please use the metric M8 screws with length of 10 to 15 mm to secure the display with the mounting system.
- Please have a professional installer to install the display unit.

Start up AVer CP System

Power on

1. Turn on the interactive display with the 100V-240V 50Hz/60Hz AC power supply. The power cord should be completely plugged into the Power inlet, and insert the power connector into the appliance couplers at the bottom side. The power current must be grounded.

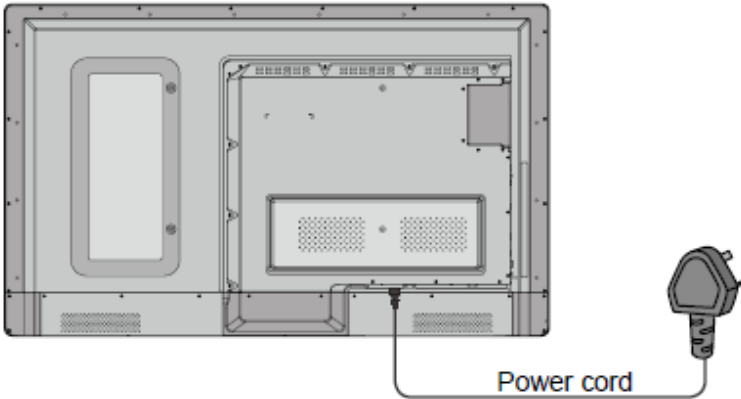

2. Connect the display to the power supply. Switch on the rocker switch (on the right bottom of the rear of the display, next to the power port) to enter the standby status. The power indicator turns red.

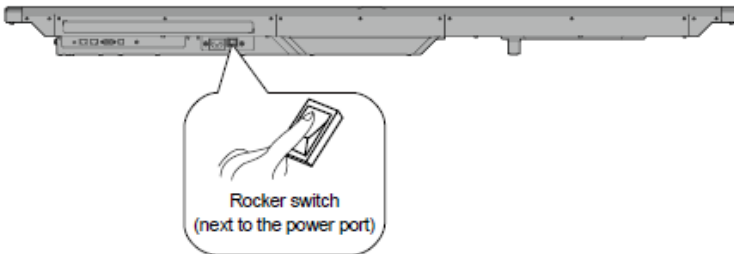

3. Press power switch on the control panel or **Power on** the remote controller to turn on the interactive display. The OPS computer will boot if one is present. The power indicator turns green.



Power switch
(on the front panel)

Power off

1. Press **PC Power** to turn off the OPS (for all-in-one models only).

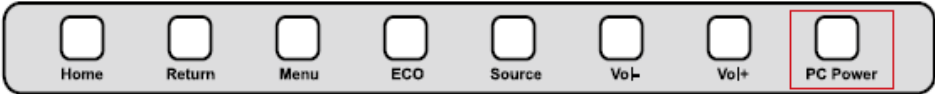

2. Press **Power** on the control panel or **Power** on the remote controller to enter the standby mode. The power indicator turns red.
3. In the standby mode, switch off the rocker switch to turn off the interactive display.

[Note]

- Please turn off the OPS before you turn off the interactive display. Otherwise, the computer may be damaged.
- Disconnect the interactive display from power after the display enters standby mode. Otherwise, the display may be damaged. A sudden power failure may damage the interactive display.
- Frequent power on and off in a short time may cause faults.
- Status of the power indicator is as follows:

Power Indicator	Status
No light	Powered off
Red	Standby
Green	Powered on

Thermal Shutdown

In the running status, the overall temperature will be increased due to unfavorable ventilation environment and long working hours. When the system detects the actual temperature higher than the defined temperature, the temperature protecting program will run automatically, the system will turn to the standby mode. You shouldn't reboot the system within two minutes.

Calibration

To ensure that the handwriting display works properly, you need to make the handwriting shown on the display coincide with the actual handwriting. The highly accurate coincidence can be achieved by software positioning. Software positioning must be implemented in the following scenarios:

- This is your first time your computer is connected to the panel.
- The driver program is reinstalled.
- The display is connected to another PC.

The handwriting display adopts nine-point positioning method. The positioning process is described as follows:

1. Please download the software from below URL link:
<http://averusa.com/classroom-technology/support/>
2. Connect the display and run the software program.
3. Click the software program icon on the right bottom of the screen. The following figure is displayed.

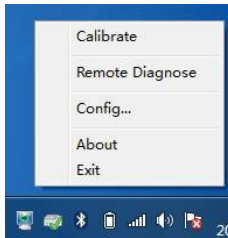

4. Select 9 Points, click Calibrate and the following figure is displayed.

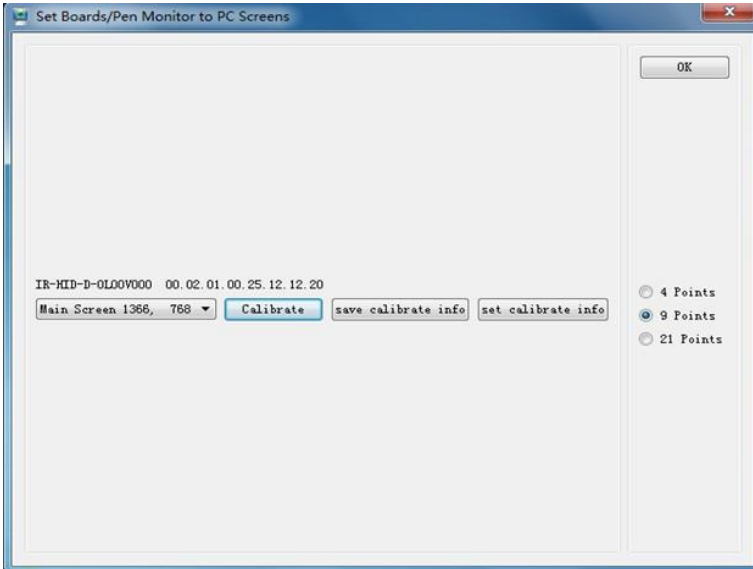

5. Use the pen to click and hold the center of the flickering cross. Do not release it until the flickering cross moves to the next point. Repeat and complete the positioning process according to the instructions on the interface. The software interface returns to the desktop automatically after the positioning is completed successfully.

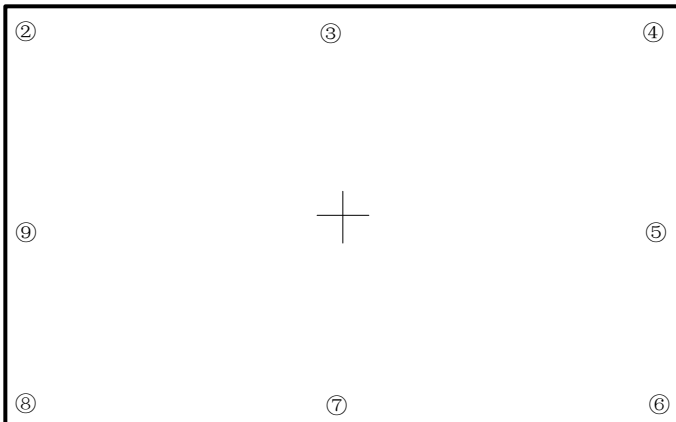

OPS Installation

[Note] The OPS does not support hot-plugging. Please insert the plug of the OPS after the interactive display is disconnected from the power.

1. Install the OPS by the following steps:
2. Insert the OPS into the special slot on the rear of the interactive display.
3. Tighten the screws.
4. Confirm the OPS is installed correctly.

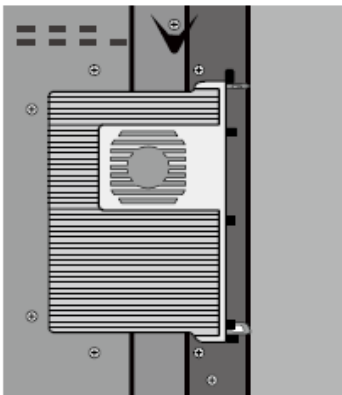



Using The AVer CP System

Main Screen

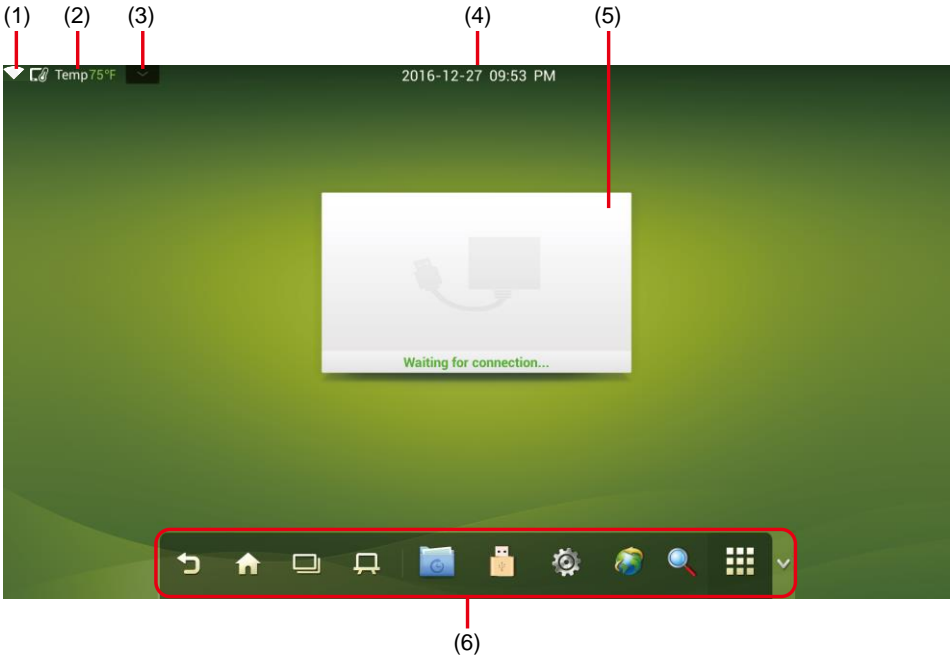
After login, the main screen will display as shown.



Name	Descriptions
(1) WiFi status	Indicates WiFi current status (Optional).
(2) System temperature	Display system's temperature. Touch the temperature display area on screen to switch between Celsius and Fahrenheit.
(3) Timer, Time, Date, Calculator	Touch  will call out Timer, Time, Date, and Calculator on screen. Touch  to hide the functions.





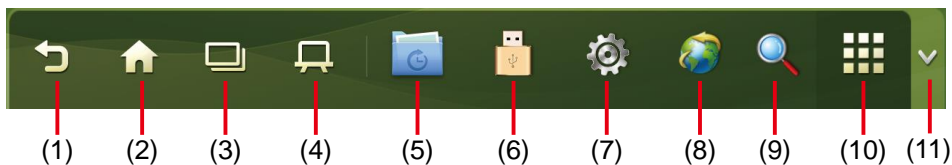

Name	Descriptions
(4) Time & Date	Display current time and date.
(5) Connection Display	Display the current devices connected to AVer CP system.
(6) Tool bar	Multifunction tool bar. Refer to Toolbar section for detail description. Touch  can hide the toolbar. To bring out the toolbar, use finger to touch the bottom of screen.

Toolbar

The toolbar is located at bottom of the screen, use one finger to swipe the screen from the bottom up to bring out the toolbar. Touch  to hide the toolbar.



Name	Descriptions
(1) 	Back to previous screen.
(2) 	Return to main screen.
(3) 	View recent running programs, switch to one of running program, and close the running programs. Refer to " Task manager " section.
(4) 	Select to switch to Whiteboard mode. Refer to " Whiteboard mode " section for more details.
(5) 	Open the gallery application.

Name**Descriptions**

(6)



Call out the file management page. The system file is displayed by default. To view external device files, press  to select the files in the SD card and USB drive. In the file management page, user can select, copy, and delete files.

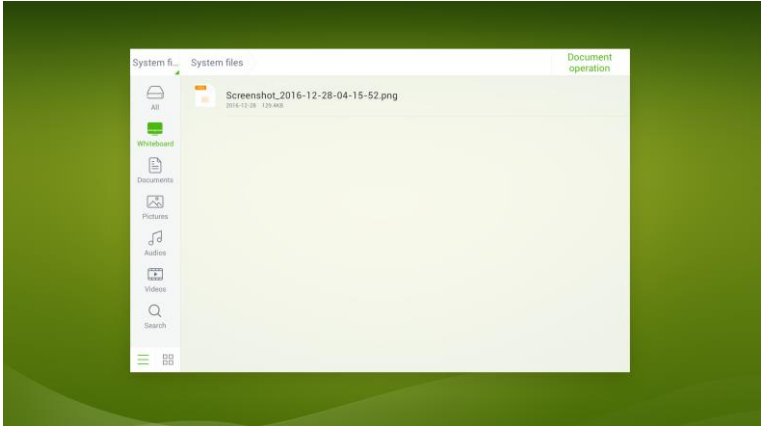

(7)



Call out system setting page. System setting includes Network, App, Language & Input, Date & Time, Energy Saving Setup, Power on/off setting, Clear screen shots, Printer, Authorization setting, and Smart eye protection.

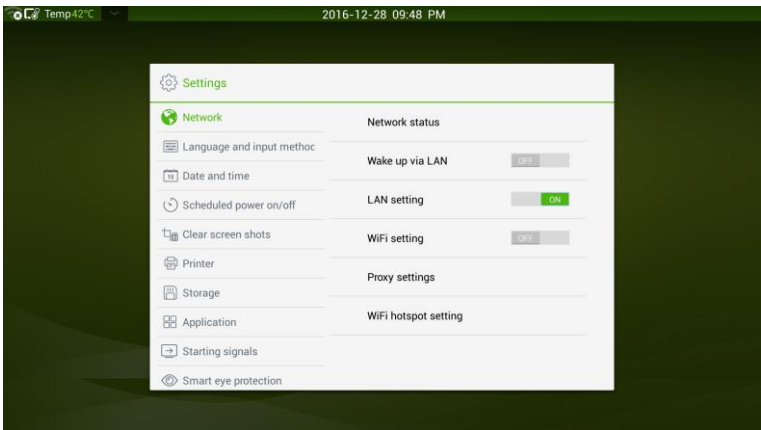

(8)



Call out browser to explore the Internet if Internet connection is available.

(9)



Call out search page to search.

Name**Descriptions**

(10)



To enter the application program page. All application programs in the system are displayed. Swipe right and left to turn the page.



(11)



Hide the toolbar.

Task Manager

In the task management, you can view current running applications, switch and end applications. Click  to enter the task management mode.

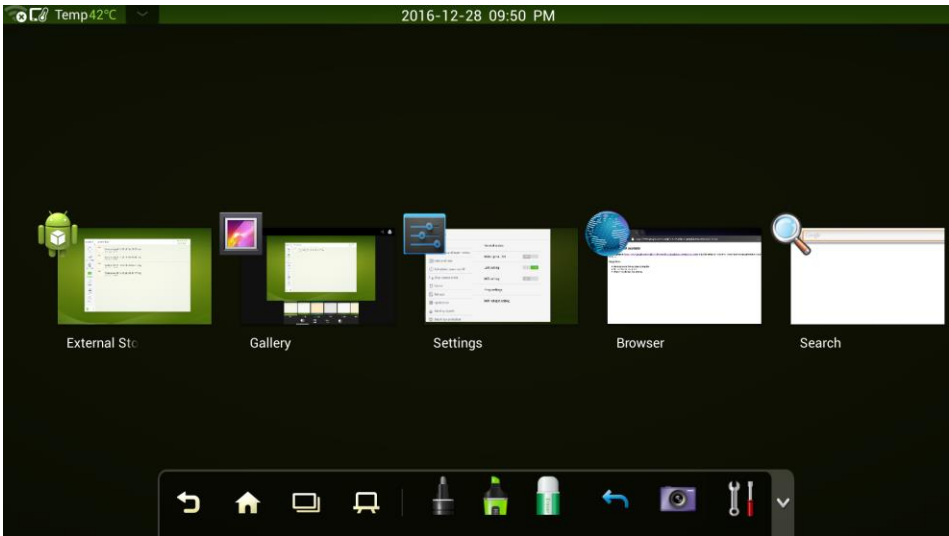

■ View Running Applications

Swipe left and right to view all currently running applications.

■ Switch Application

Click on any window to switch to the application. For example, click Settings to switch to the system setting page, or click Browser to switch to the browser page.

■ Close Application

Swipe on the application up or down to terminate the application.

Select Signal Source

There are three ways to select a signal source:

- Press “**SOURCE**” button on the remote controller.
- Press “**Source**” button on the control panel of the interactive display.

In the source page, press ▲ and ▼ button on remote controller to select a source and press **OK** to confirm the selection. User also can directly select the source icon on the screen



Single Source Mode Setting

After switching to the source page, press **MENU** on the remote controller and the setting menu is displayed. Use **▲** and **▼** button on remote controller to select a setting option and press **OK** to confirm the selection. For different input sources, the settings might be different.

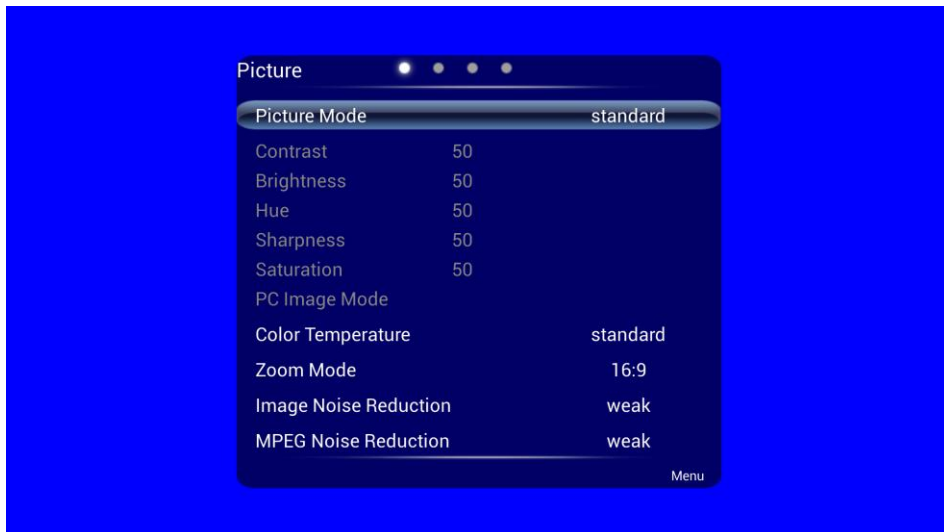

Whiteboard Mode

The whiteboard provides the write and draw function. In the whiteboard program, User can select a pen, line weight and color to write or draw, and use an eraser to erase content on the whiteboard. User also can print and clear the content on the whiteboard.

Click  on the toolbar or press **Whiteboard** on the remote controller to enter the whiteboard interface.

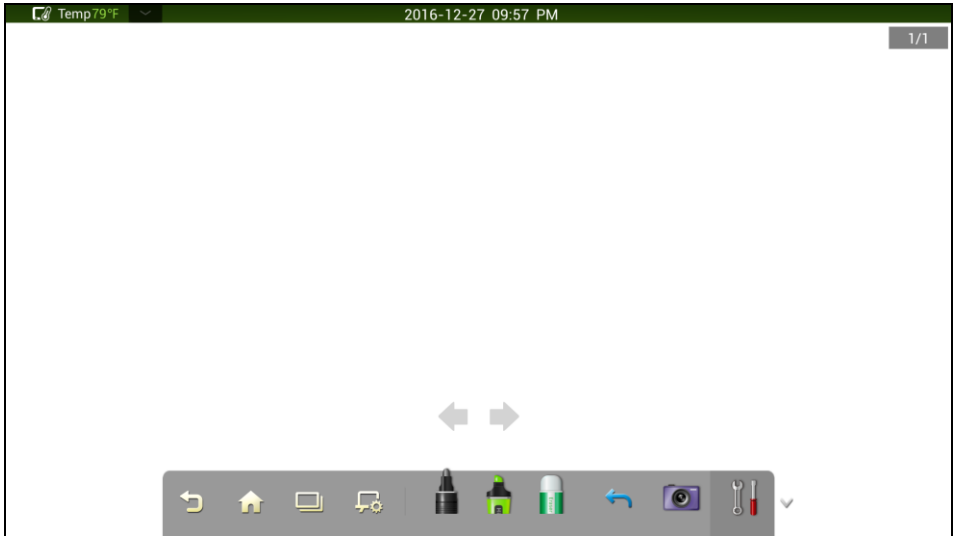

New Page/Overview/Delete all

■ New Page

Click  icon and select “New page” to add a new Whiteboard page.

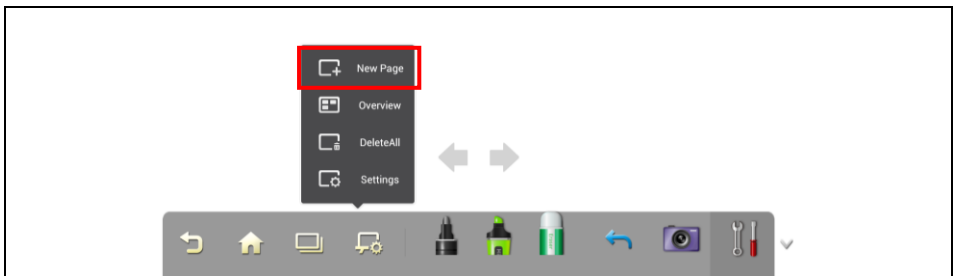

■ Overview

Select “**Overview**” to view all Whiteboard pages. User can select or delete  the Whiteboard page in the overview page.

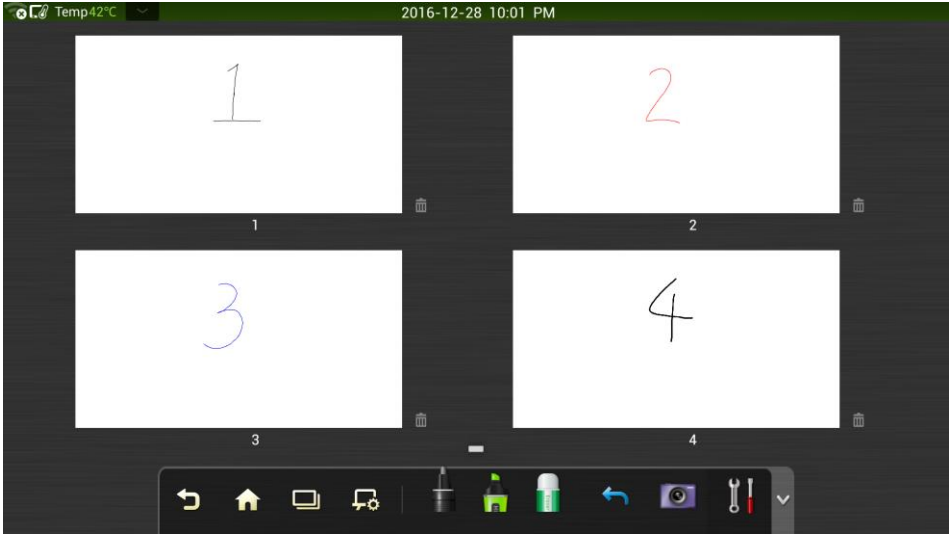

■ Delete all

Select “**Delete all**” will delete all Whiteboard pages at once.

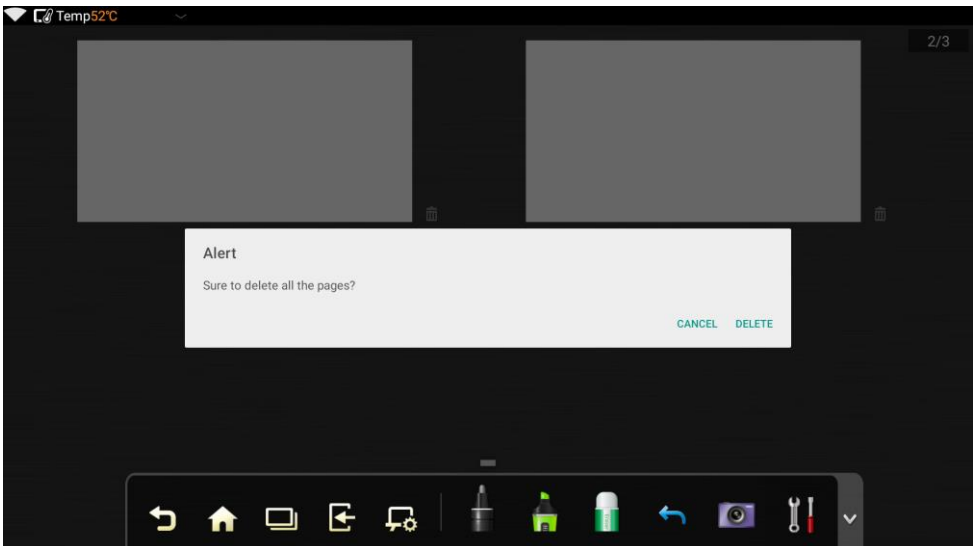

Settings

Click  icon and select “**Settings**” to setup color and shade of whiteboard page. The setting is applied to all whiteboard pages.

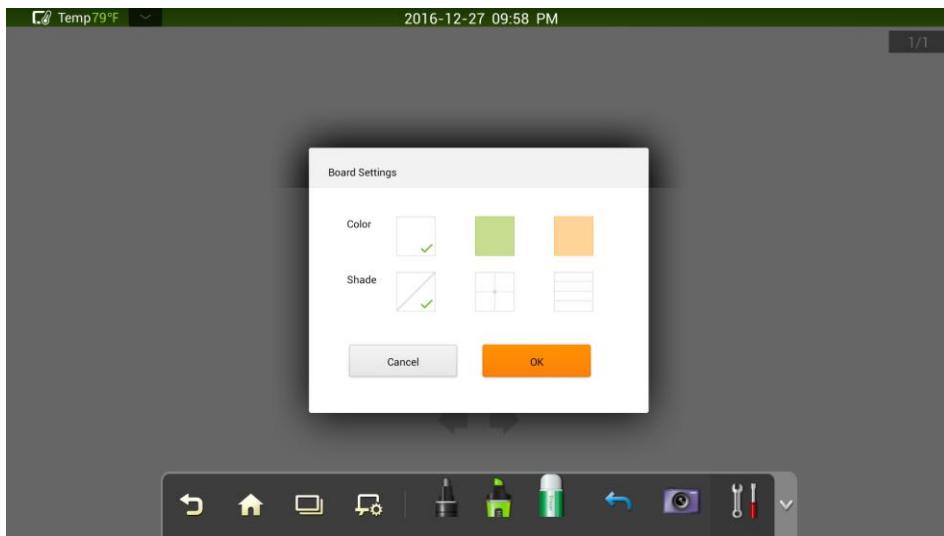

Pen

Select and hold  for two seconds to set its line weight and color.

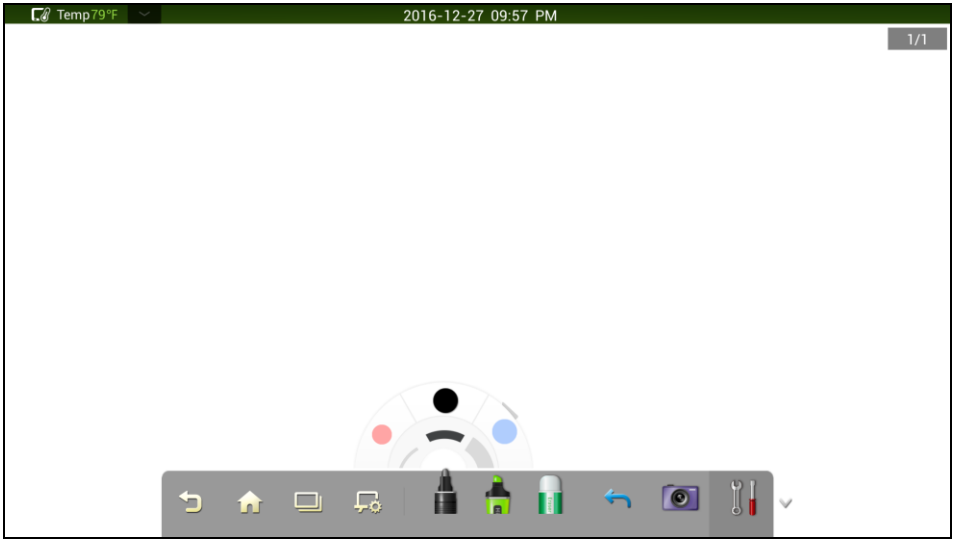

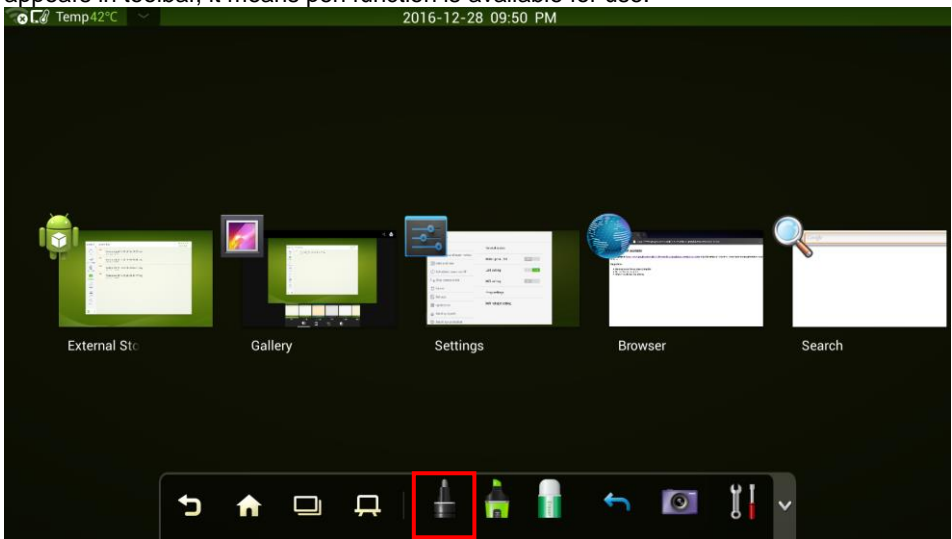

Pen function can be used in outside of Whiteboard mode. When user sees  icon appears in toolbar, it means pen function is available for use.

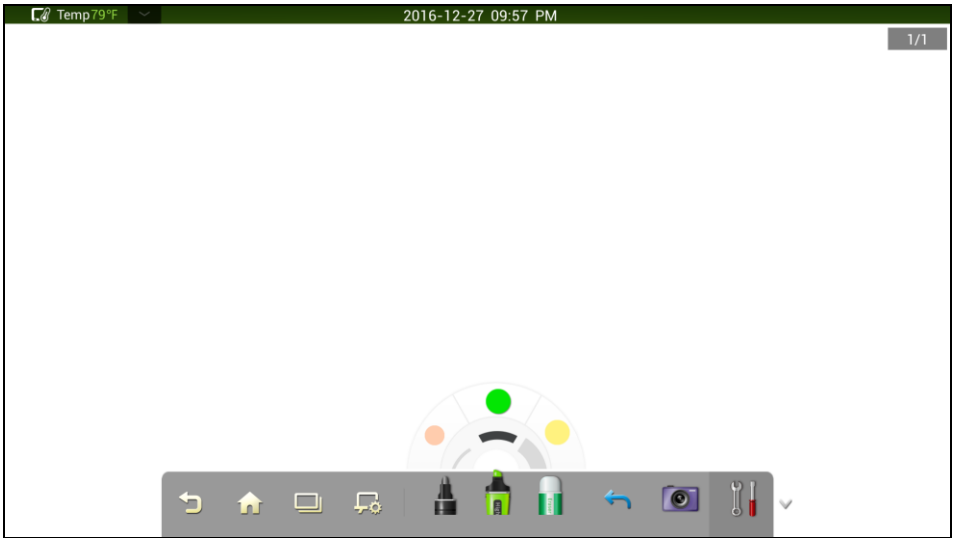

Highlighter

Select and hold  for two seconds to set its line weight and color.



Highlighter function can be used in outside of Whiteboard mode. When user sees  icon appears in toolbar, it means highlighter function is available for use.

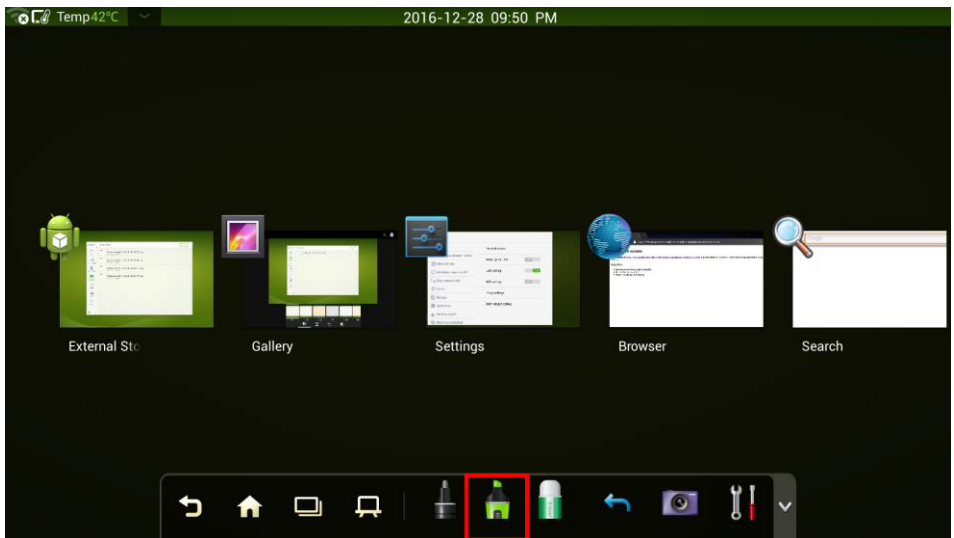

Eraser

Select  icon to erase the content on the whiteboard.

Also, user can use five fingers to touch the screen and a big circle is displayed indicating the scope for erasing. Move the circle to erase the contents.



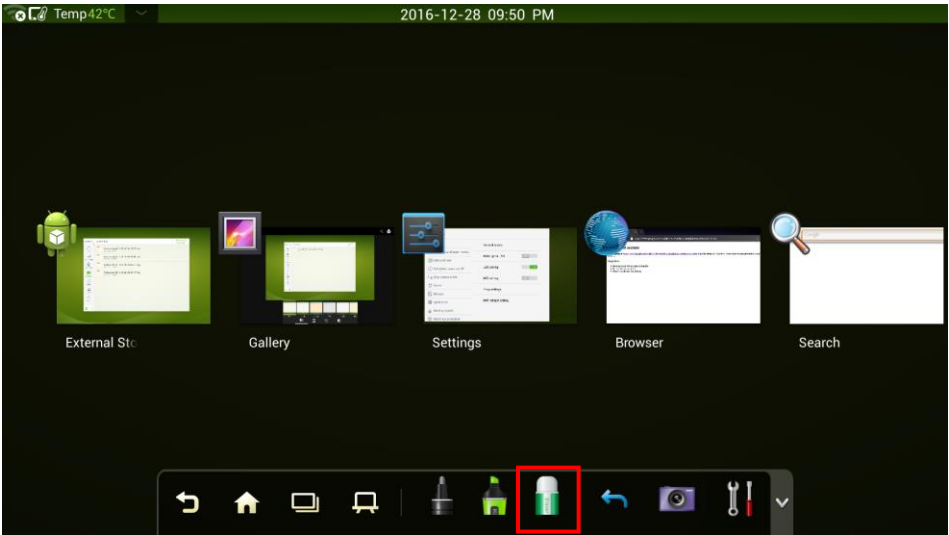

Eraser function can be used inside or outside of Whiteboard mode. When user sees  icon appears in toolbar, it means eraser function is available for use.

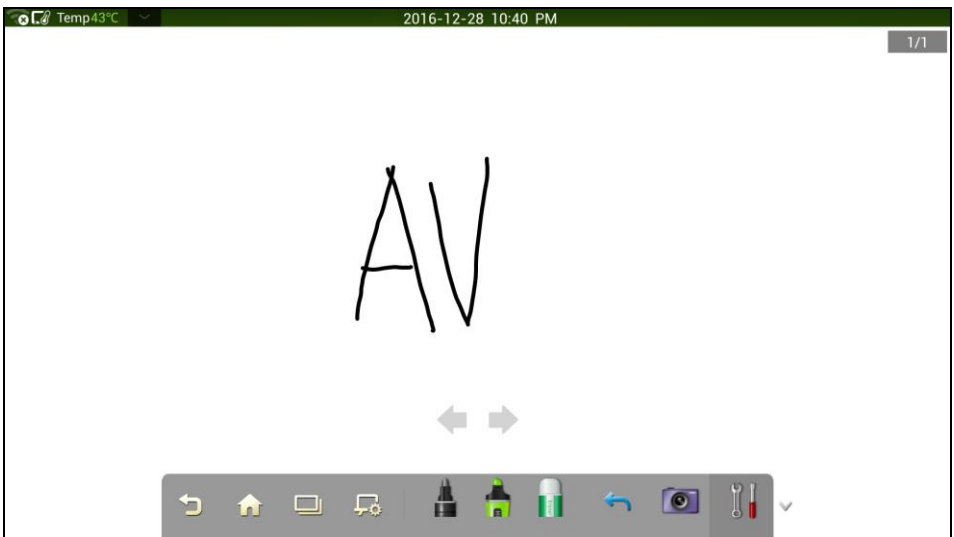

Go Back

Select  icon to go back to the last action that user has done on whiteboard.





Go back function can be used inside or outside of Whiteboard mode. When user sees  icon appears in toolbar, it means go back function is available for use.

Screen Capture

Click  to capture current contents on the whiteboard and save it as an image to system directory (The toolbar is not captured).

Also, user can press “**CAPTURE**” button on the remote controller to save current content on the whiteboard, too.

To view the screenshot images, go to main screen and select  icon and system file folder will display. In system file folder, select “**Pictures**”, and then select the image that user wants to view.

Capture function can be used inside or outside of Whiteboard mode. When user sees  icon appears in toolbar, it means capture function is available for use.

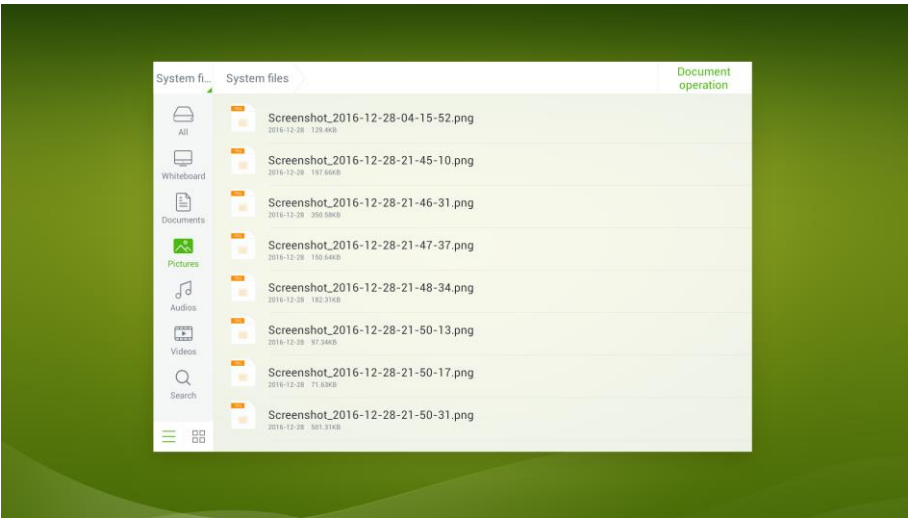

User also can select Gallery application () to view all screenshot images.

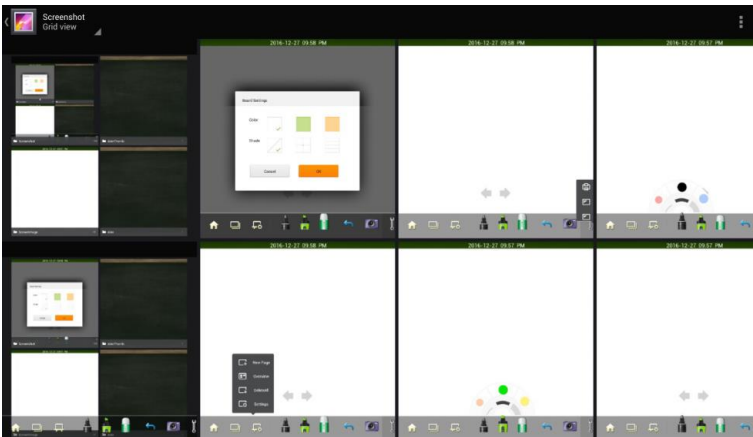

Print, Clear and Freeze Screen

Select  icon to perform Print, Clear and Freeze screen functions.

- **Print:** If user has setup the printer, user can print out the current content of whiteboard.
- **Clear:** To clear all current contents on the whiteboard.
- **Freeze Screen:** To capture the current screen and can do zoom in, zoom out, annotation on the screen.

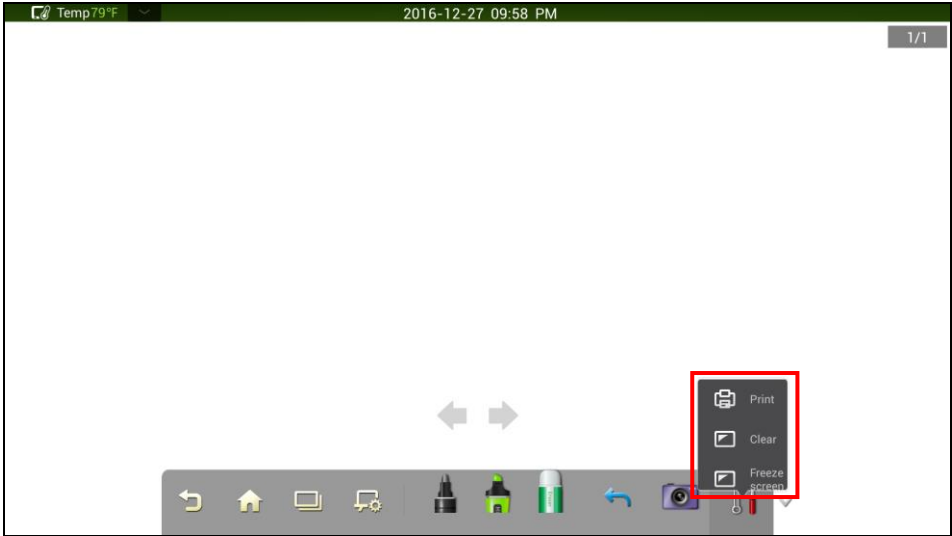

Print, Clear, and Freeze Screen function can be used inside or outside of Whiteboard mode.

When user sees  icon appears in toolbar, it means Print, Clear, and Freeze Screen function is available for use.

Gallery

You can enter the gallery to view images one by one or play them as slides.

Click  in the application programs to enter the gallery. All folders containing images are displayed.

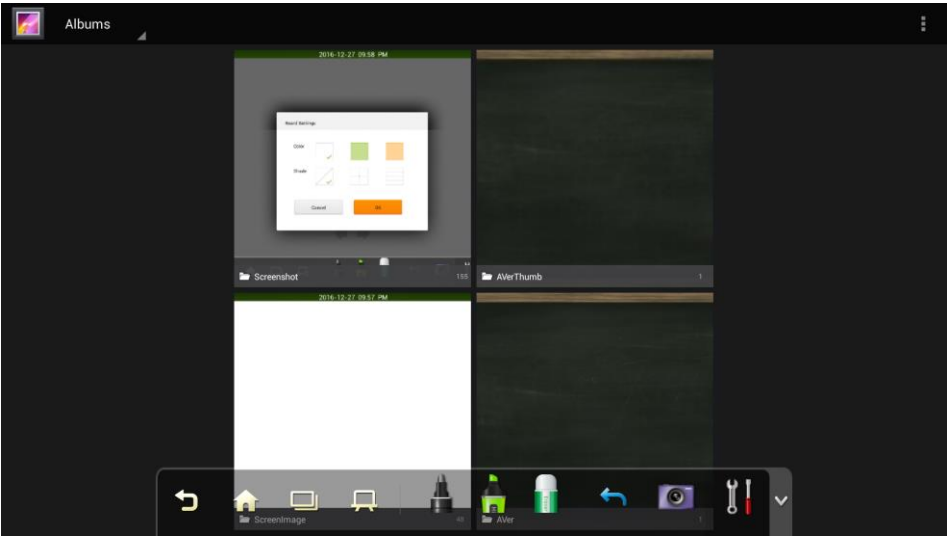

■ Full preview

One full screen can display a maximum of eight images; you can preview other group image by using your finger to swipe left or right. Using long press on screen to select multiple images, and then you can click  icon on the upper right corner to slideshow, select item, and group the images.

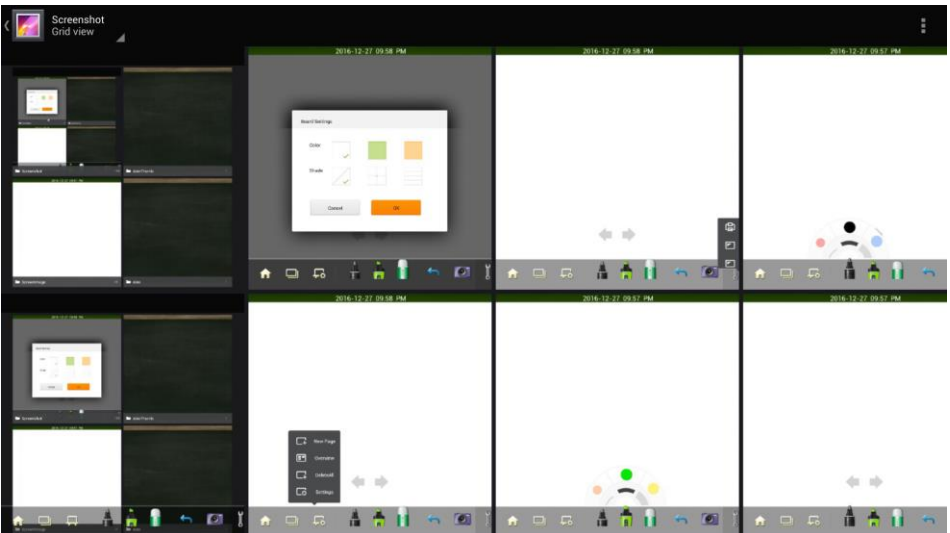

■ View images one by one

Click one image in a folder. Scroll left to show the previous image and scroll right to show the next image.

■ Play slides

Click  on the upper right corner of the folder and select **Slideshow** to play images as slides.

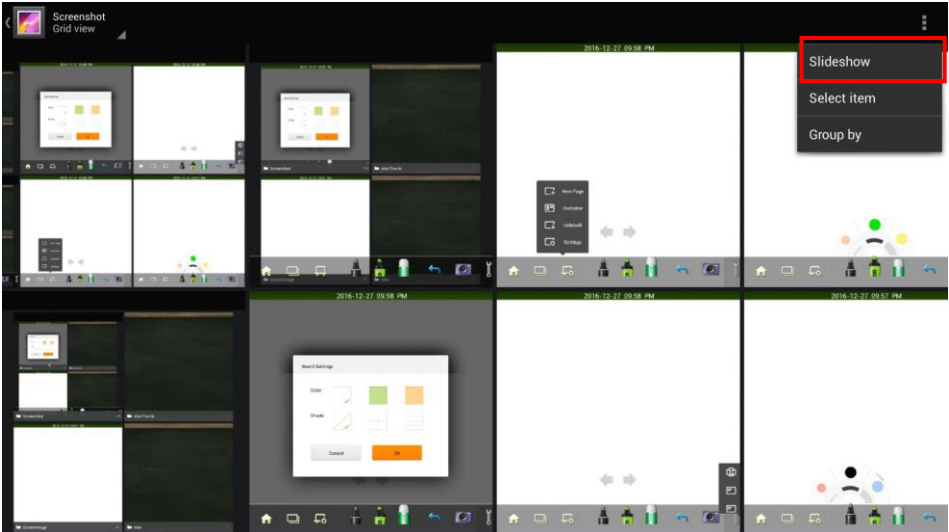

Copy Files

Copy files from system to external USB pen drive.

1. Plug in the USB pen drive to “Android USB port” on the front panel.
2. Select “” icon on screen. The system file folder screen will display on screen. Select the file type that user wants to copy; ex: document, pictures.

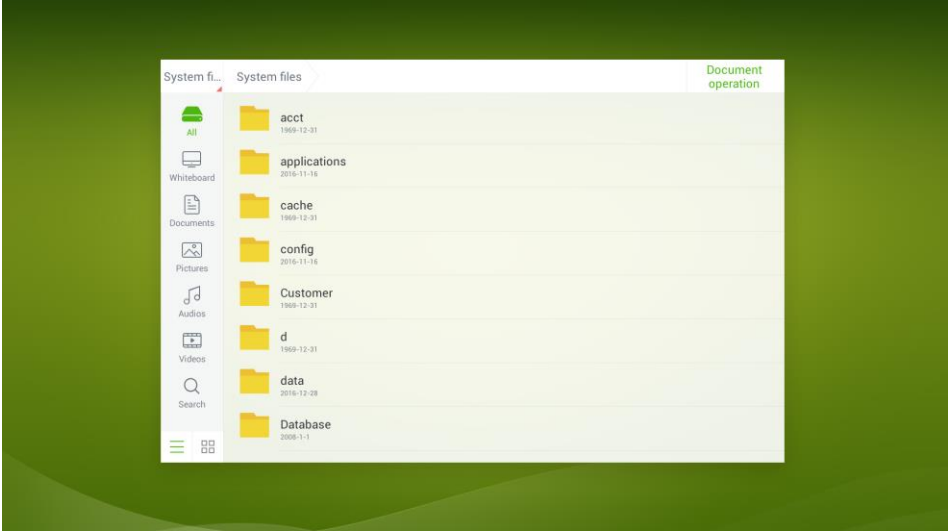

3. Select the “**Document operation**”, and then select the files that user wants to copy. Or user can select “**Select all**” to select all files.
4. After selecting files, select “**Copy**”.

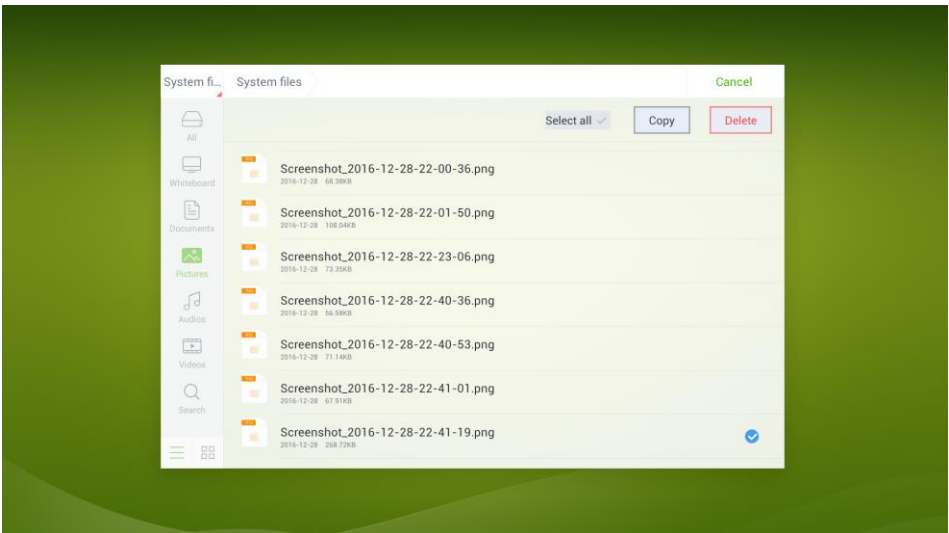

5. Next, select  to change to external USB pen drive directory. Then, select **"Paste"** and selected file will copy into external USB pen drive.

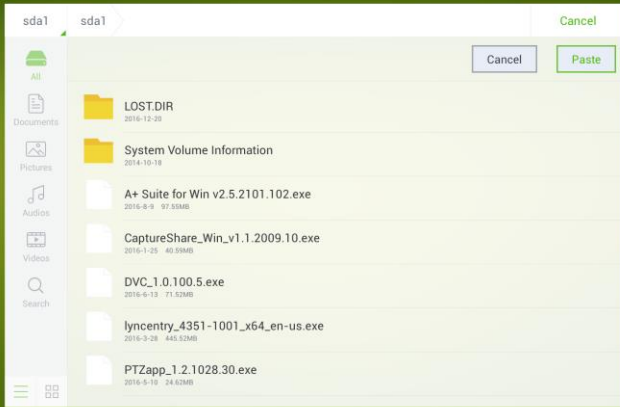

Kids Safety Lock

Press **ECO** button on the remote controller or font panel for more than 5 seconds can turn on screen locked mode, too. Under screen locked mode, press ECO for more than 5 seconds again to unlock. An icon in the following figure will show on the top-right corner on the screen if the device is under screen locked mode.

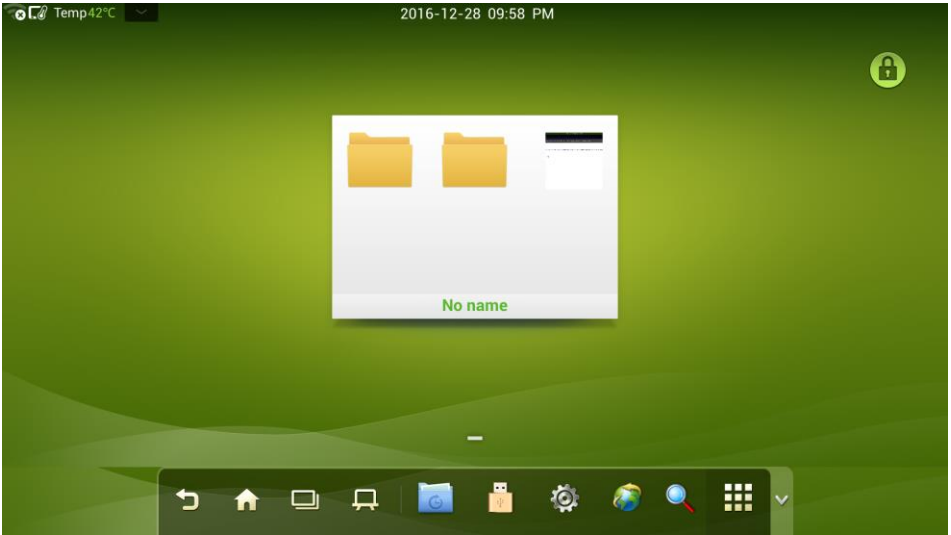

ECO Mode

[Note]

- Please switch off the display when it is not used, and enable the function of Audio Only when you do not need to watch the display, helping to reduce power consumption and save energy.
- On the premise of ensuring viewing effect, the energy consumption can be reduced by lowering display brightness.

Press **ECO** on the remote controller to enter the backlight mode page. Press **ECO** to switch among **ECO**, **Auto** and **Standard**.

- **ECO mode:** The power output is reduced 50%.
- **Auto mode:** System automatically adjusts the screen brightness according to the light in the environment. When the light is strong, the screen brightens. When the light is weak, the screen darkens.
- **Standard mode:** The screen brightness keeps the same.

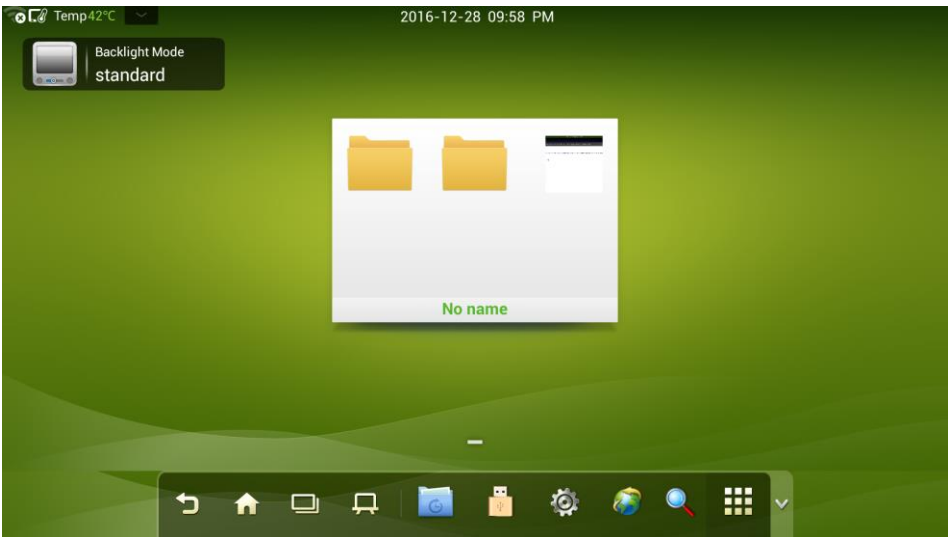

Specification

Serial Port Control

The RS-232 port of the interactive display is defined as follows:

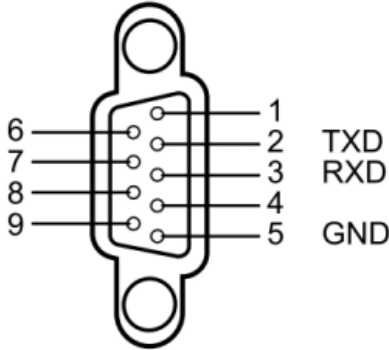

Connect RS-232 port to the PC or controlling device. Enable RS-232 serial port connection and complete the following configuration.

Port Number: COM 1 (Set the value according to the port number of the PC or controlling device)

Bit rate	19200	Odd/even check	None
Data bit	8	Stop bit	1

The following table lists button controlling codes. The buttons share same functions with corresponding buttons on the remote controller.

Function	Controlling Code	Function	Controlling Code
Power on	7F 08 99 A2 B3 C4 02 FF 01 00 CF	1	7F 08 99 A2 B3 C4 02 FF 01 21 CF
Power off	7F 08 99 A2 B3 C4 02 FF 01 01 CF	2	7F 08 99 A2 B3 C4 02 FF 01 22 CF
Mute	7F 08 99 A2 B3 C4 02 FF 01 02 CF	3	7F 08 99 A2 B3 C4 02 FF 01 23 CF
Sound mode	7F 08 99 A2 B3 C4 02 FF 01 05 CF	4	7F 08 99 A2 B3 C4 02 FF 01 24 CF
Signal source	7F 08 99 A2 B3 C4 02 FF 01 06 CF	5	7F 08 99 A2 B3 C4 02 FF 01 25 CF
One button start	7F 08 99 A2 B3 C4 02 FF 01 07 CF	6	7F 08 99 A2 B3 C4 02 FF 01 26 CF

Function	Controlling Code	Function	Controlling Code
Display status	7F 08 99 A2 B3 C4 02 FF 01 09 CF	7	7F 08 99 A2 B3 C4 02 FF 01 27 CF
HDMI 1	7F 08 99 A2 B3 C4 02 FF 01 0A CF	8	7F 08 99 A2 B3 C4 02 FF 01 28 CF
HDMI 2	7F 08 99 A2 B3 C4 02 FF 01 0B CF	9	7F 08 99 A2 B3 C4 02 FF 01 29 CF
HDMI 3	7F 08 99 A2 B3 C4 02 FF 01 0C CF	0	7F 08 99 A2 B3 C4 02 FF 01 2A CF
Internal PC(OPS)	7F 08 99 A2 B3 C4 02 FF 01 38 CF	OK	7F 08 99 A2 B3 C4 02 FF 01 2B CF
HDMI 4	7F 08 99 A2 B3 C4 02 FF 01 51 CF	←	7F 08 99 A2 B3 C4 02 FF 01 2C CF
DP	7F 08 99 A2 B3 C4 02 FF 01 56 CF	→	7F 08 99 A2 B3 C4 02 FF 01 2D CF
VGA	7F 08 99 A2 B3 C4 02 FF 01 0D CF	↑	7F 08 99 A2 B3 C4 02 FF 01 2E CF
AV	7F 08 99 A2 B3 C4 02 FF 01 11 CF	↓	7F 08 99 A2 B3 C4 02 FF 01 2F CF
Up	7F 08 99 A2 B3 C4 02 FF 01 13 CF	Menu	7F 08 99 A2 B3 C4 02 FF 01 1B CF
Down	7F 08 99 A2 B3 C4 02 FF 01 14 CF	Home page	7F 08 99 A2 B3 C4 02 FF 01 1C CF
Listen alone	7F 08 99 A2 B3 C4 02 FF 01 15 CF	Return (Exit)	7F 08 99 A2 B3 C4 02 FF 01 1D CF
ECO	7F 08 99 A2 B3 C4 02 FF 01 16 CF	Search	7F 08 99 A2 B3 C4 02 FF 01 1E CF
VOL -	7F 08 99 A2 B3 C4 02 FF 01 17 CF	Capture	7F 08 99 A2 B3 C4 02 FF 01 1F CF
VOL +	7F 08 99 A2 B3 C4 02 FF 01 18 CF	Auto ADJ	7F 08 99 A2 B3 C4 02 FF 01 20 CF

Function	Controlling Code	Function	Controlling Code
Freeze	7F 08 99 A2 B3 C4 02 FF 01 3B CF	Acoustic mode	7F 08 99 A2 B3 C4 02 FF 03 XX CF [Note] XX indicate various mode: 00-Standard, 01-Music, 02-Film, 03-News, 04-User, 05-temporary 1, 06-temporary 2
volume setting	7F 08 99 A2 B3 C4 02 FF 05 XX CF	Energy saving mode	7F 08 99 A2 B3 C4 02 FF 06 XX CF [Note] XX indicate various mode: 00-standard, 01-energy saving, 02-auto
Firmware version query	7F 08 99 A2 B3 C4 02 FF 01 3D CF	Backlight brightness increase	7F 08 99 A2 B3 C4 02 FF 01 47 CF
Backlight brightness decrease	7F 08 99 A2 B3 C4 02 FF 01 48 CF	Backlight brightness setting	7F 08 99 A2 B3 C4 02 FF 09 XX CF
Switch child lock	7F 08 99 A2 B3 C4 02 FF 01 57 CF	Child lock mode	7F 08 99 A2 B3 C4 02 FF 01 58 CF

VGA Signal Input

VGA (Video Graphics Array) is the computer display standard for analog signal. VGA port is the special port on the computer which uses the VGA standard for data input. The following table lists the specifications of various VGA signal input.

[Note]

The VGA signal input is available only when the display is in PC mode.

SN	Standard	Resolution	Refresh Rate (Hz)	Horizontal Frequency (KHz)	Vertical Frequency (Hz)	Horizontal/Vertical Sync Polarity (TTL)
1	VESA	640x480	60	31.5	60	N/N
2	VESA	640x480	72	37.9	72	N/N
3	VESA	640x480	75	37.5	75	N/N
4	VESA	800x600	56	35.1	56	P/P
5	VESA	800x600	60	37.9	60	P/P
6	VESA	800x600	72	48.1	72	P/P
7	VESA	800x600	75	46.9	75	P/P
8	VESA	1024x768	60	48.4	60	N/N
9	VESA	1024x768	70	56.5	70	N/N
10	VESA	1024x768	75	60	75	N/N
11	VESA	1280x960	60	60	60	N/N
12	VESA	1280x960	75	75.159	75	N/N
13	VESA	1280x1024	60	64	60	P/P
14	VESA	1280x1024	75	80	75	P/P
15	VESA	1600x1200	60	75	60	P/P
16	VESA	1920x1080	60	66.547	59.988	P/P

Multimedia Format Support

Media Type	File Format	File Extension
Image	JPEG, BMP, PNG	.jpg, .bmp, .png
Movie	MPEG1, MPEG2, MPEG4, H.264, H.265, RM, RMVB, MOV, MJPEG, VC1, DivX, FLV (Support 1080P, 4K HD Decoding)	.avi, mpg, .dat, .vob, .div, .mov, .mkv, .rm, .rmvb, .mp4, .ts, .trp, .asf, .flv
Music	MP3, M4A, (AAC)	.mp3, .m4a
Text	TXT	.txt

Common Faults and Solutions

Symptom	Possible Cause	Solution
The service program fails to connect.	The drive program is not correctly installed.	Install the drive program correctly.
	The USB port (lead) is not connected or is faulty.	Change the USB lead or check if the USB port is faulty.
	The infrared tube is blocked.	Ensure that the surrounding infrared tubes are not blocked.
Repositioning is required every time the display is switched on.	The computer is equipped with a recovery card.	Disable computer protection and perform the positioning again.
The positioning is inaccurate.	The positioning is not performed properly.	Press AUTO on the remote controller to show the full screen, and use the pen provided with the display to perform positioning again.
The cursor of the pen is unstable when the pen is used.	The writing method is incorrect.	You are advised to use the pen rather than a finger to write. Hold the pen as far to the nib as possible. The angle between the pen and display needs to be greater than 60 degrees. Do not touch the display with your sleeve or wrist.

Symptom	Possible Cause	Solution
	Strong light or infrared interference exists.	Remove the interference source or change the using environment.
The handwriting is discontinuous. (Part of the handwriting cannot be displayed.)	The writing method is incorrect.	You are advised to use the pen rather than a finger to write. Hold the pen as far to the nib as possible. The angle between the pen and display needs to be greater than 60 degrees. Do not touch the display with your sleeve or wrist.
	The covering area of the nib does not meet the requirement or the nib is too small.	Change the nib or use a pen with larger covering area.
	The infrared tube is blocked.	Check if infrared tubes are blocked.
	Strong light or infrared interference exists.	Remove the interference source or change the using environment.
The handwriting cannot be shown or no touch signal is detected.	The color of the pen is the same as or similar to the background color.	Change the color of the pen.
	Your hand or other objects are on the display when you are writing.	You are advised to use the pen rather than a finger to write. Hold the pen as far to the nib as possible. The angle between the pen and display needs to be greater than 60 degrees. Do not touch the display with your sleeve or wrist.
	Strong light or infrared interference	Remove the interference source or change the using environment.

Symptom	Possible Cause	Solution
	The writing method is incorrect.	You are advised to use the pen rather than a finger to write. Hold the pen as far to the nib as possible. The angle between the pen and display needs to be greater than 60 degrees. Do not touch the display with your sleeve or wrist.
Not sound is played and no image is displayed.	<ul style="list-style-type: none"> ■ Check whether the power plug is inserted into the power socket and whether the display is powered on. ■ Check whether the rocker switch on the interactive display is switched on. ■ Check whether the Standby button on the remote controller is pressed. ■ Check whether the video and audio input cables are connected correctly. ■ Check whether the display is switched to the right signal source. ■ Check the settings on image brightness and contrast. ■ Check the volume. 	
Image is displayed properly, but no sound is played.	<ul style="list-style-type: none"> ■ Check the volume. ■ Check whether the Mute button on the remote controller is pressed. ■ Check whether the audio cable between the PC and interactive display is connected correctly. 	
No image is displayed or the image is black and white.	<ul style="list-style-type: none"> ■ Modify the color settings. ■ Check the color system. 	
The image or sound is interrupted.	<ul style="list-style-type: none"> ■ Find out the electric appliance that causes the interference and move it away from the interactive display. ■ Do not share the power socket of the display with the electric appliance that causes interference. 	
The remote controller fails.	<ul style="list-style-type: none"> ■ Change the batteries. ■ Clean the signal emitter at the top of the remote controller. (Check whether it is blocked.) ■ Check contacts of the batteries. 	

Symptom	Possible Cause	Solution
The PC cannot be started. (This scenario is applicable only to display models operating with the PC.)	<ul style="list-style-type: none"> ■ Check whether the PC adapter is correctly connected and whether the PC is powered on. ■ Check whether the PC is connected correctly to the interactive display. 	

The following symptoms are not considered faulty symptoms:

A very few of constantly bright or dark pixels, such as tiny red, blue, green or dark points, may exist on the LED. This symptom is not a fault and does not affect the operation of the display.

Slight sound may occur due to the backlight adjustment or ventilation. This is a normal symptom.

The image and sound are normal. However, you can sense static electricity when you touch the LED and metal back cover. This is a normal symptom.

Technical Specification

Specification	Parameter
Active Screen Size (inches)	65"
Display Backlight	LED
Display Ratio	Landscape 16:9
Resolution	1920*1080 Pixel
LCD Brightness	370cd/m2
Contrast Ratio (typical)	4000:1
Response Time (typical)	8ms
Viewing Angle	178°
Power Consumption	Maximum <220W Standby Mode ≤0.5W
Touch Surface Material	Tempered Glass
Touch Surface Technology	Anti-Glare Glass
Transparency	>88%
Touch Sensor	Infrared
Touch Points	10 Points
Touch Screen Writing Tools	Writing Pen or Finger
Positioning Accuracy	5mm
Communication Interface	USB-B
Speaker Position	Forward
Speaker Max.Power Output	15W x 2

*We may modify the user manual without prior notice.

*If you discover any unclear presentation, mistake or omission in this manual, please contact us immediately.

Care and Maintenance

Maintenance Tips

Do not put or install the product near a heat source or under direct sunlight, or in dusty or humid places, or somewhere the product may be hit or damaged by mechanical vibration. To maximize the performance, it needs to be put away from equipment such as grid, large metal objects and radar stations as far as possible.

Do not wipe the display with any chemical reagent. Solvents may damage the enclosure or paint. If the display is stained by dust, cut off the power and then clean the display using a dried cloth with a little of warm water. Use a clean soft cloth to clean the LED of the display. Do not frequently switch on and off the product, which may shorten the product service life. After the display is switched off, wait for three minutes before switching it on again. If the product is not to be used for a long period of time, please power off the product and pull out the power plug.

Do not maximize the brightness and contrast of the LED for a long period of time, which may shorten the LED service life.

Do not use a hard object to write on the display, which may scratch the LED.

Clean the Infrared Tube

The interactive display uses the horizontal and vertical infrared matrix to detect and locate the user's touch. The screen is surrounded by an infrared tube (including the infrared acceptor and emitter), which forms an infrared net covering on the screen surface. When a user touches the screen, fingers or other opaque objects block the infrared rays that cross the touch point, which helps the controller detect the coordinate position of the touch point. Dust is easily retained on the screen surface due to its long-term exposure in the air and causes ineffective touch or inaccurate positioning. Therefore, you need to clean the infrared tube around the screen regularly.

